

2W isolated DC-DC converter
Fixed input voltage, unregulated dual/ single output

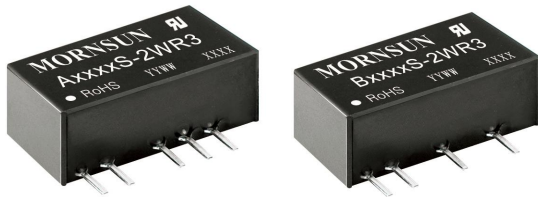

Patent Protection RoHS

UL 62368-1 EN 62368-1 IEC62368-1

A_S-2WR3 & B_S-2WR3 series are specially designed for applications where an (two) isolated voltage is required in a distributed power supply system. They are suitable for:

1. The voltage of the input power supply is relatively stable with a variation of $\pm 10\%V_{in}$ or less;
2. An input to output isolation voltage of up to 1500VDC is necessary;
3. The requirement for a tight output regulation is not as strict.

FEATURES

- Continuous short-circuit protection
- No-load input current as low as 8mA
- Operating ambient temperature range: -40°C to $+105^{\circ}\text{C}$
- High efficiency up to 86%
- High power density
- I/O isolation test voltage 1.5k VDC
- Industry standard pin-out

Selection Guide

Certification	Part No.	Input Voltage (VDC)	Output		Full Load Efficiency (%) Min./Typ.	Capacitive Load*(μF) Max.	
		Nominal (Range)	Voltage (VDC)	Current (mA) Max./Min.			
UL/EN/IEC	A1203S-2WR3	12 (10.8-13.2)	± 3.3	$\pm 303/\pm 30$	71/75	1200	
	A1205S-2WR3		± 5	$\pm 200/\pm 20$	76/80		
--	A1207S-2WR3		± 7.2	$\pm 139/\pm 13$	76/80	470	
	A1209S-2WR3		± 9	$\pm 111/\pm 11$	78/82		
UL/EN/IEC	A1212S-2WR3		± 12	$\pm 83/\pm 8$	79/83	220	
	A1215S-2WR3		± 15	$\pm 67/\pm 7$	79/83		
--	A1224S-2WR3		± 24	$\pm 42/\pm 4$	79/83	100	
UL/EN/IEC	B1203S-2WR3		3.3	400/40	75/79	2400	
	B1205S-2WR3		5	400/40	78/82	2400	
--	B1209S-2WR3		9	222/22	78/82	1000	
UL/EN/IEC	B1212S-2WR3		12	167/17	80/84	560	
	B1215S-2WR3		15	133/13	81/85		
	B1224S-2WR3		24	83/8	82/86		
--	A1505S-2WR3		15 (13.5-16.5)	± 5	$\pm 200/\pm 20$	76/80	1200
	A1515S-2WR3			± 15	$\pm 67/\pm 7$	78/82	220
	B1505S-2WR3			5	400/40	76/80	2400
	B1515S-2WR3	15		133/13	77/81	560	
	B1524S-2WR3	24		83/8	77/81	220	
UL/EN/IEC	A2403S-2WR3	24 (21.6-26.4)	± 3.3	$\pm 303/\pm 30$	70/76	1200	
	A2405S-2WR3		± 5	$\pm 200/\pm 20$	74/80		
--	A2407S-2WR3		± 7.2	$\pm 139/\pm 13$	74/80	470	
	A2409S-2WR3		± 9	$\pm 111/\pm 11$	75/81		
UL/EN/IEC	A2412S-2WR3		± 12	$\pm 83/\pm 8$	77/83	220	
	A2415S-2WR3		± 15	$\pm 67/\pm 7$	77/83		
--	A2424S-2WR3		± 24	$\pm 42/\pm 4$	77/83	100	
	B2403S-2WR3		3.3	400/40	70/76	2400	
UL/EN/IEC	B2405S-2WR3		5	400/40	74/80	2400	
	B2409S-2WR3		9	222/22	75/81	1000	

UL/EN/IEC	B2412S-2WR3	24 (21.6-26.4)	12	167/17	78/84	560
UL/EN/IEC	B2415S-2WR3		15	133/13	80/86	
	B2424S-2WR3		24	83/8	80/86	220

Note: * The specified maximum capacitive load for positive and negative output is identical.

Input Specifications

Item	Operating Conditions	Min.	Typ.	Max.	Unit
Input Current (full load / no-load)	12V input	--	223/8	235/--	mA
	15V input	--	167/8	176/--	
	24V input	--	110/8	120/--	
Reflected Ripple Current		--	15	--	
Surge Voltage (1sec. max.)	12V input	-0.7	--	18	VDC
	15V input	-0.7	--	21	
	24V input	-0.7	--	30	
Input Filter		Capacitance filter			
Hot Plug		Unavailable			

Output Specifications

Item	Operating Conditions	Min.	Typ.	Max.	Unit	
Voltage Accuracy		See output regulation curve(Fig. 1)				
Linear Regulation	Input voltage change: $\pm 1\%$	3.3VDC output	--	--	± 1.5	--
		Others	--	--	± 1.2	
Load Regulation	10%-100% load	3.3VDC output	--	15	--	%
		5VDC output	--	7	--	
		7.2VDC output	--	6	--	
		9VDC output	--	5	--	
		12VDC output	--	5	--	
		15VDC output	--	4	--	
		24VDC output	--	3	--	
Ripple & Noise*	20MHz bandwidth	--	75	180	mVp-p	
Temperature Coefficient	Full load	--	± 0.02	--	%/°C	
Short-circuit Protection		Continuous, self-recovery				

Notes: * The "parallel cable" method is used for ripple and noise test, please refer to DC-DC Converter Application Notes for specific information.

General Specifications

Item	Operating Conditions	Min.	Typ.	Max.	Unit
Isolation	Input-output electric strength test for 1 minute with a leakage current of 1mA max.	1500	--	--	VDC
Insulation Resistance	Input-output resistance at 500VDC	1000	--	--	M Ω
Isolation Capacitance	Input-output capacitance at 100kHz/0.1V	--	20	--	pF
Operating Temperature	Derating when operating temperature $\geq 85^\circ\text{C}$, (see Fig. 2)	-40	--	105	°C
Storage Temperature		-55	--	125	
Case Temperature Rise	Ta=25°C	--	15	--	
Pin Soldering Resistance Temperature	Soldering spot is 1.5mm away from case for 10 seconds	--	--	300	
Storage Humidity	Non-condensing	5	--	95	%RH
Vibration		10-150Hz, 5G, 0.75mm. along X, Y and Z			
Switching Frequency	Full load, nominal input voltage	--	260	--	kHz
MTBF	MIL-HDBK-217F @ 25°C	3500	--	--	k hours

Mechanical Specifications

Case Material	Black plastic; flame-retardant and heat-resistant (UL94-V0)
Dimensions	19.65 x 7.05 x 10.16mm
Weight	2.4g(Typ.)
Cooling Method	Free air convection

Electromagnetic Compatibility (EMC)

Emission	CE	CISPR32/EN55032	CLASS B
	RE	CISPR32/EN55032	CLASS B
Immunity	ESD	IEC/EN61000-4-2	Air ±8kV, Contact ±6kV perf. Criteria B

Note: Refer to Fig.4 for recommended circuit test

Typical Performance Curves

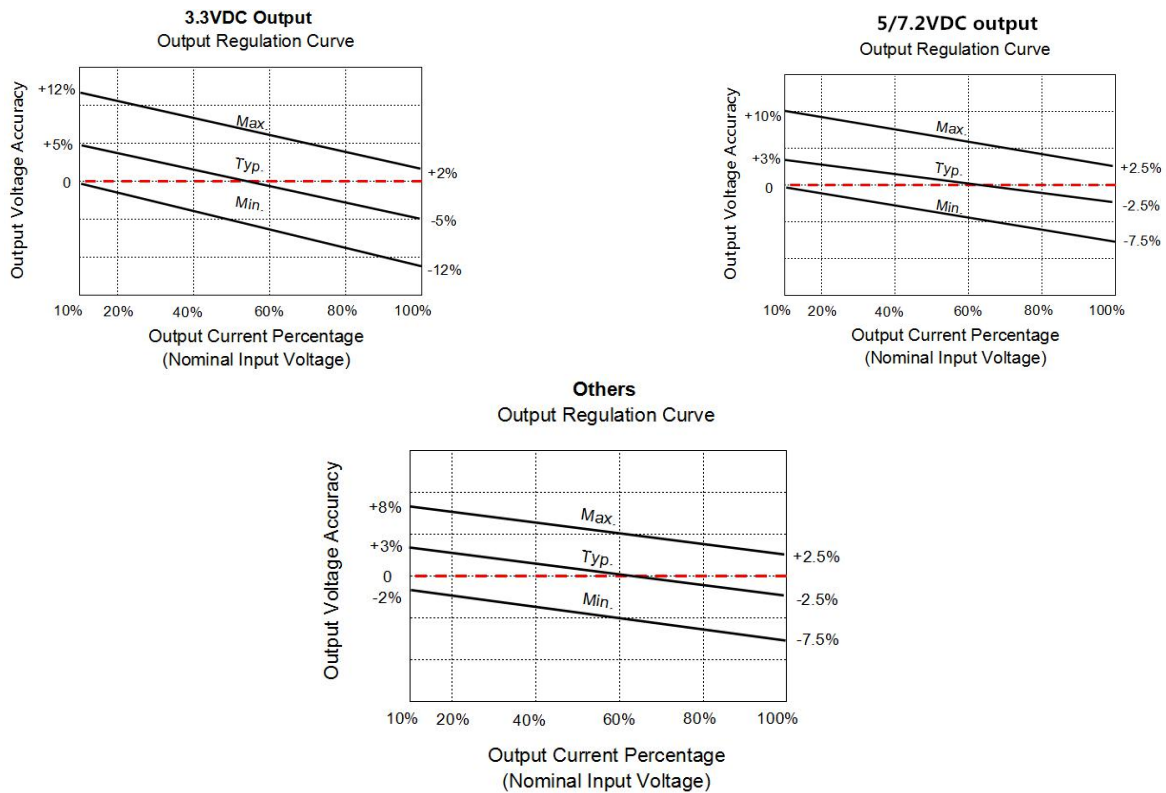

Fig. 1

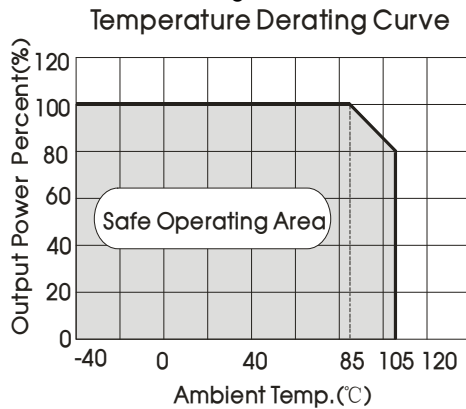

Fig. 2

Design Reference

1. Typical application

Input and/or output ripple can be further reduced, by connecting a filter capacitor from the input and/or output terminals to ground as shown in Fig.3.

Choosing suitable filter capacitor values is very important for a smooth operation of the modules, particularly to avoid start-up problem caused by capacitor values that are too high. For recommended input and output capacitor values refer to Table 1.

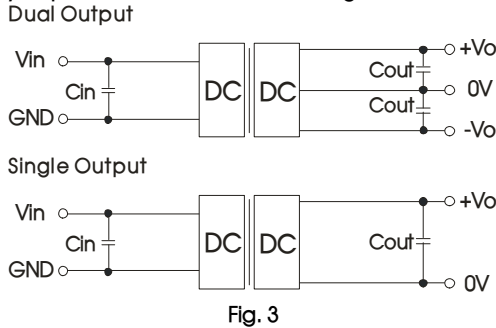

Fig. 3

Table 1: Recommended input and output capacitor values

Vin	Cin	Single Vout	Cout	Dual Vout	Cout'
12VDC	2.2μF/25V	3.3VDC	10μF/16V	±3.3VDC	4.7μF/16V
15VDC	2.2μF/25V	5VDC	10μF/16V	±5VDC	4.7μF/16V
24VDC	1μF/50V	9VDC	2.2μF/25V	±7.2VDC	2.2μF/25V
--	--	12VDC	2.2μF/25V	±9VDC	2.2μF/25V
--	--	15VDC	1μF/25V	±12VDC	1μF/25V
--	--	24VDC	1μF/50V	±15VDC	1μF/25V
--	--	--	--	±24VDC	0.47μF/50V

Note: The capacitor value of the positive and the negative output is identical.

2. EMC compliance circuit

Single Output

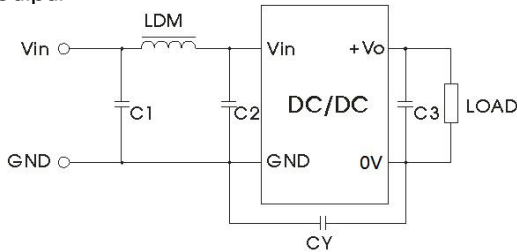

Dual Output

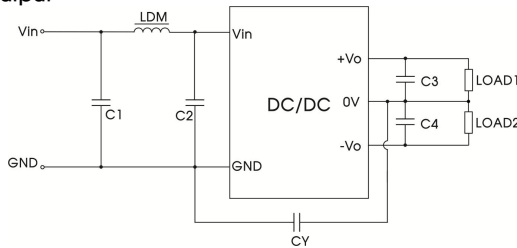

Fig. 4

Input voltage		12/15/24VDC
Emission	C1/C2	4.7μF /50V
	CY	270pF /2kV
	C3	Refer to Cout in Fig.3
	LDM	6.8μH

Input voltage		12/15/24VDC
Emission	C1/C2	4.7μF /50V
	CY	270pF /2kV
	C3/C4	Refer to Cout in Fig.3
	LDM	6.8μH

3. For additional information, please refer to DC-DC converter application notes on www.mornsun-power.com

Dimensions and Recommended Layout

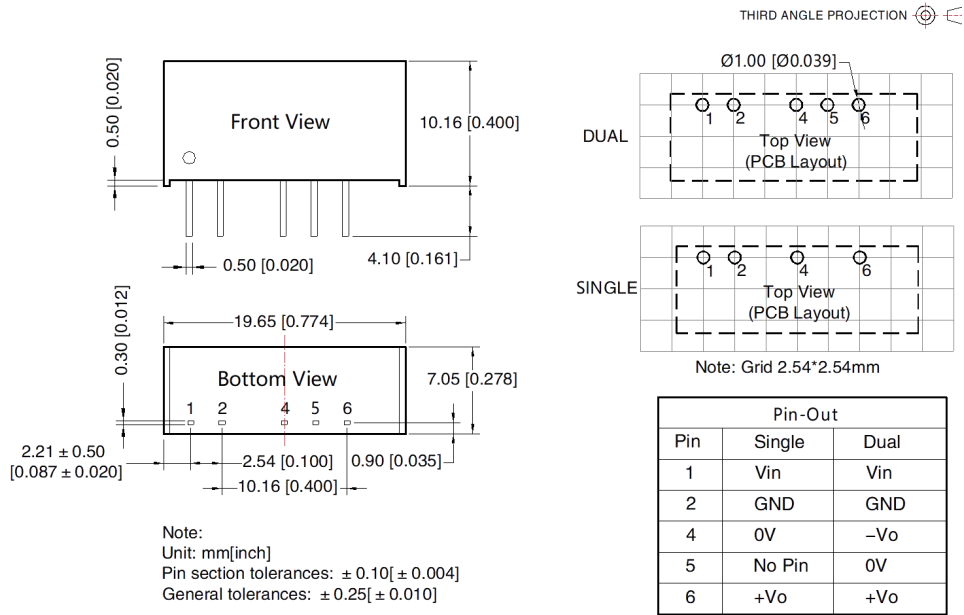

Notes:

1. For additional information on Product Packaging please refer to www.mornsun-power.com. Packaging bag number: 58200001;
2. If the product is not operated within the required load range, the product performance cannot be guaranteed to comply with all parameters in the datasheet;
3. The maximum capacitive load offered were tested at input voltage range and full load;
4. Unless otherwise specified, parameters in this datasheet were measured under the conditions of $T_a=25^\circ\text{C}$, humidity<75%RH with nominal input voltage and rated output load;
5. All index testing methods in this datasheet are based on our company corporate standards;
6. We can provide product customization service, please contact our technicians directly for specific information;
7. Products are related to laws and regulations: see "Features" and "EMC";
8. Our products shall be classified according to ISO14001 and related environmental laws and regulations, and shall be handled by qualified units.

MORNSUN Guangzhou Science & Technology Co., Ltd.

Address: No. 5, Kehui St. 1, Kehui development center, Science Ave., Guangzhou Science City, Huangpu district, Guangzhou, P.R. China

Tel: 86-20-38601850

Fax: 86-20-38601272

E-mail: info@mornsun.cn

www.mornsun-power.com