



September 2014



ES3A - ES3J Fast Rectifiers

Features

- For Surface Mount Applications
- Glass-Passivated Junction
- Low-Profile Package
- Easy Pick and Place
- Built-in Strain Relief
- Superfast Recovery Times for High Efficiency

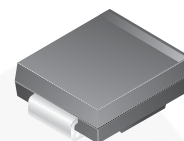

SMC/DO-214AB
COLOR BAND DENOTES CATHODE

Ordering Information

Part Number	Top Mark	Package	Packing Method
ES3A	ES3A	DO-214AB (SMC)	Tape and Reel
ES3B	ES3B	DO-214AB (SMC)	Tape and Reel
ES3C	ES3C	DO-214AB (SMC)	Tape and Reel
ES3D	ES3D	DO-214AB (SMC)	Tape and Reel
ES3J	ES3J	DO-214AB (SMC)	Tape and Reel

Absolute Maximum Ratings

Stresses exceeding the absolute maximum ratings may damage the device. The device may not function or be operable above the recommended operating conditions and stressing the parts to these levels is not recommended. In addition, extended exposure to stresses above the recommended operating conditions may affect device reliability. The absolute maximum ratings are stress ratings only. Values are at $T_A = 25^\circ\text{C}$ unless otherwise noted.

Symbol	Parameter	Value					Unit
		ES3A	ES3B	ES3C	ES3D	ES3J	
V_{RRM}	Maximum Repetitive Reverse Voltage	50	100	150	200	600	V
$I_{F(AV)}$	Average Rectified Forward Current, .375" Lead Length at $T_A = 75^\circ\text{C}$	3.0					A
I_{FSM}	Non-Repetitive Peak Forward Surge Current 8.3 ms Single Half-Sine Wave	100					A
T_J, T_{STG}	Operating Junction and Storage Temperature Range	-50 to +150					$^\circ\text{C}$

Thermal Characteristics

Values are at $T_A = 25^\circ\text{C}$ unless otherwise noted.

Symbol	Parameter		Value	Unit
P_D	Power Dissipation		1.66	W
$R_{\theta JA}$	Thermal Resistance, Junction to Ambient ⁽¹⁾	Maximum Land Pattern: 16 x 16 mm	47	$^\circ\text{C}/\text{W}$
		Minimum Land Pattern: 2.6 x 3.2 mm	125	
$R_{\theta JL}$	Thermal Resistance, Junction to Lead ⁽¹⁾	Maximum Land Pattern: 16 x 16 mm	12	$^\circ\text{C}/\text{W}$
		Minimum Land Pattern: 2.6 x 3.2 mm	16	

Note:

1. Device mounted on FR-4 PCB 0.013 mm.

Electrical Characteristics

Values are at $T_A = 25^\circ\text{C}$ unless otherwise noted.

Symbol	Parameter	Conditions	Value					Unit
			ES3A	ES3B	ES3C	ES3D	ES3J	
V_F	Maximum Forward Voltage	$I_F = 3.0\text{ A}$	0.95			1.70	V	
t_{rr}	Reverse Recovery Time	$I_F = 0.5\text{ A},$ $I_R = 1.0\text{ A},$ $I_{RR} = 0.25\text{ A}$	Typ.	20		35	ns	
			Max.	30		45		
I_R	Maximum Reverse Current at Rated V_R	$T_A = 25^\circ\text{C}$	10			μA		
		$T_A = 100^\circ\text{C}$	500					
C_T	Total Capacitance	$V_R = 4.0\text{ V}, f = 1.0\text{ MHz}$	45			pF		

Typical Performance Characteristics

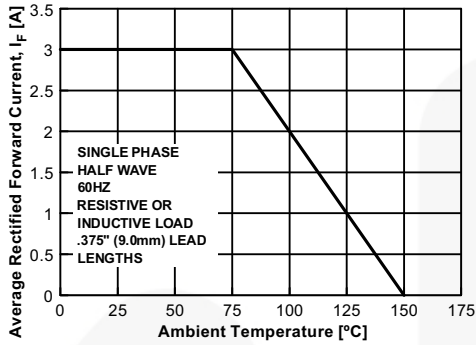

Figure 1. Forward Current Derating Curve

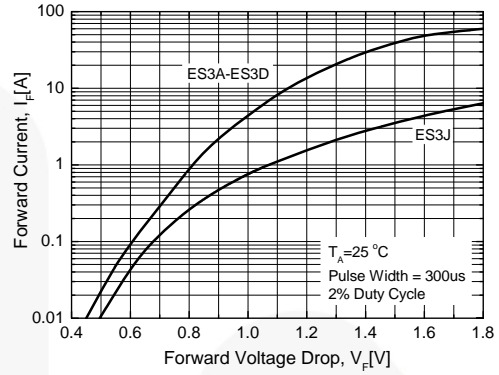

Figure 2. Forward Voltage Characteristics

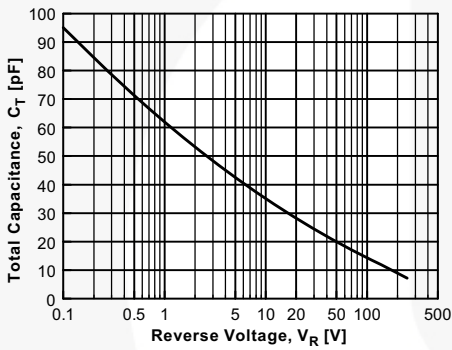

Figure 3. Total Capacitance

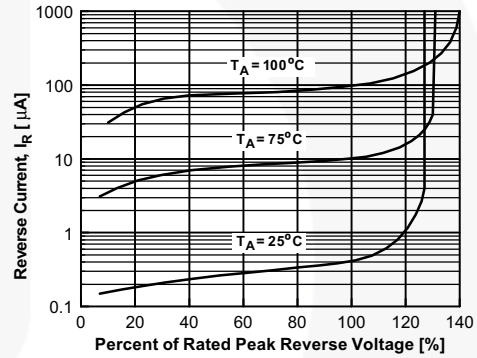
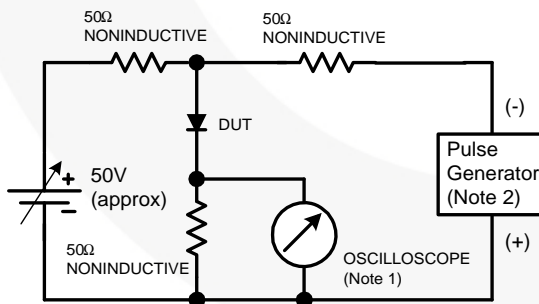

Figure 4. Reverse Current vs. Reverse Voltage



NOTES:

1. Rise time = 7.0 ns max; Input impedance = 1.0 megaohm 22 pf.
2. Rise time = 10 ns max; Source impedance = 50 ohms.

Figure 5. Reverse Recovery Time Characteristic and Test Circuit Diagram

Physical Dimension

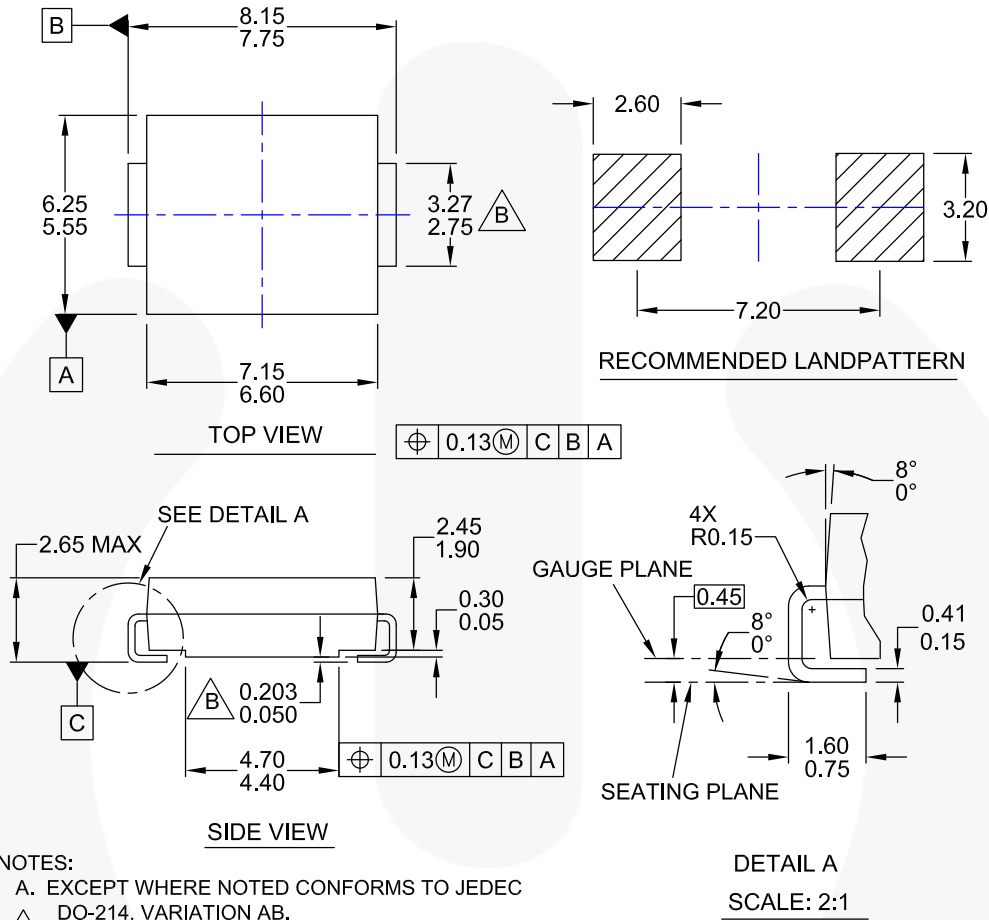

- NOTES:
- A. EXCEPT WHERE NOTED CONFORMS TO JEDEC DO-214, VARIATION AB.
 - B. DOES NOT COMPLY TO JEDEC STD. VALUE.
 - C. ALL DIMENSIONS ARE IN MILLIMETERS.
 - D. DIMENSIONS ARE EXCLUSIVE OF BURRS, MOLD FLASH, AND TIE BAR PROTRUSIONS.
 - E. DIMENSIONS AND TOLERANCING AS PER ASME Y14.5M-1994
 - F. LAND PATTERN STANDARD: DIOM7957X241M
 - G. DRAWING FILE NAME: DO214ABREV1

Figure 6. 2-LEAD, SMC, JEDEC DO-214, VARIATION AB (ACTIVE)





TRADEMARKS

The following includes registered and unregistered trademarks and service marks, owned by Fairchild Semiconductor and/or its global subsidiaries, and is not intended to be an exhaustive list of all such trademarks.

AccuPower™	F-PFST™		
Awinda®	FRFET®	PowerTrench®	TinyBoost®
AX-CAP®*	Global Power Resource SM	PowerXS™	TinyBuck®
BitSiC™	GreenBridge™	Programmable Active Droop™	TinyCalc™
Build it Now™	Green FPS™	QFET®	TinyLogic®
CorePLUS™	Green FPS™ e-Series™	QS™	TINYOPTO™
CorePOWER™	Gmax™	Quiet Series™	TinyPower™
CROSSVOLT™	GTO™	RapidConfigure™	TinyPWM™
CTL™	IntelliMAX™		TinyWire™
Current Transfer Logic™	ISOPLANAR™	Saving our world, 1mW/W/kW at a time™	TranSiC™
DEUXPEED®	Making Small Speakers Sound Louder and Better™	SignalWise™	TriFault Detect™
Dual Cool™	MegaBuck™	SmartMax™	TRUECURRENT®*
EcoSPARK®	MICROCOUPLER™	SMART START™	µSerDes™
EfficientMax™	MicroFET™	Solutions for Your Success™	
ESBC™	MicroPak™	SPM®	UHC®
	MicroPak2™	STEALTH™	Ultra FRFET™
Fairchild®	MillerDrive™	SuperFET®	UniFET™
Fairchild Semiconductor®	MotionMax™	SuperSOT™-3	VCX™
FACT Quiet Series™	MotionGrid®	SuperSOT™-6	VisualMax™
FACT®	MTi®	SuperSOT™-8	VoltagePlus™
FAST®	MTx®	SupreMOS®	XS™
FastvCore™	MVN®	SyncFET™	Xsens™
FETBench™	mWSaver®	Sync-Lock™	仙童™
FPS™	OptoHiT™		

* Trademarks of System General Corporation, used under license by Fairchild Semiconductor.

DISCLAIMER

FAIRCHILD SEMICONDUCTOR RESERVES THE RIGHT TO MAKE CHANGES WITHOUT FURTHER NOTICE TO ANY PRODUCTS HEREIN TO IMPROVE RELIABILITY, FUNCTION, OR DESIGN. TO OBTAIN THE LATEST, MOST UP-TO-DATE DATASHEET AND PRODUCT INFORMATION, VISIT OUR WEBSITE AT [HTTP://WWW.FAIRCHILDSEMI.COM](http://www.fairchildsemi.com). FAIRCHILD DOES NOT ASSUME ANY LIABILITY ARISING OUT OF THE APPLICATION OR USE OF ANY PRODUCT OR CIRCUIT DESCRIBED HEREIN; NEITHER DOES IT CONVEY ANY LICENSE UNDER ITS PATENT RIGHTS, NOR THE RIGHTS OF OTHERS. THESE SPECIFICATIONS DO NOT EXPAND THE TERMS OF FAIRCHILD'S WORLDWIDE TERMS AND CONDITIONS, SPECIFICALLY THE WARRANTY THEREIN, WHICH COVERS THESE PRODUCTS.

LIFE SUPPORT POLICY

FAIRCHILD'S PRODUCTS ARE NOT AUTHORIZED FOR USE AS CRITICAL COMPONENTS IN LIFE SUPPORT DEVICES OR SYSTEMS WITHOUT THE EXPRESS WRITTEN APPROVAL OF FAIRCHILD SEMICONDUCTOR CORPORATION.

As used herein:

1. Life support devices or systems are devices or systems which, (a) are intended for surgical implant into the body or (b) support or sustain life, and (c) whose failure to perform when properly used in accordance with instructions for use provided in the labeling, can be reasonably expected to result in a significant injury of the user.
2. A critical component in any component of a life support, device, or system whose failure to perform can be reasonably expected to cause the failure of the life support device or system, or to affect its safety or effectiveness.

ANTI-COUNTERFEITING POLICY

Fairchild Semiconductor Corporation's Anti-Counterfeiting Policy. Fairchild's Anti-Counterfeiting Policy is also stated on our external website, www.fairchildsemi.com, under Sales Support.

Counterfeiting of semiconductor parts is a growing problem in the industry. All manufacturers of semiconductor products are experiencing counterfeiting of their parts. Customers who inadvertently purchase counterfeit parts experience many problems such as loss of brand reputation, substandard performance, failed applications, and increased cost of production and manufacturing delays. Fairchild is taking strong measures to protect ourselves and our customers from the proliferation of counterfeit parts. Fairchild strongly encourages customers to purchase Fairchild parts either directly from Fairchild or from Authorized Fairchild Distributors who are listed by country on our web page cited above. Products customers buy either from Fairchild directly or from Authorized Fairchild Distributors are genuine parts, have full traceability, meet Fairchild's quality standards for handling and storage and provide access to Fairchild's full range of up-to-date technical and product information. Fairchild and our Authorized Distributors will stand behind all warranties and will appropriately address any warranty issues that may arise. Fairchild will not provide any warranty coverage or other assistance for parts bought from Unauthorized Sources. Fairchild is committed to combat this global problem and encourage our customers to do their part in stopping this practice by buying direct or from authorized distributors.

PRODUCT STATUS DEFINITIONS

Definition of Terms

Datasheet Identification	Product Status	Definition
Advance Information	Formative / In Design	Datasheet contains the design specifications for product development. Specifications may change in any manner without notice.
Preliminary	First Production	Datasheet contains preliminary data; supplementary data will be published at a later date. Fairchild Semiconductor reserves the right to make changes at any time without notice to improve design.
No Identification Needed	Full Production	Datasheet contains final specifications. Fairchild Semiconductor reserves the right to make changes at any time without notice to improve the design.
Obsolete	Not In Production	Datasheet contains specifications on a product that is discontinued by Fairchild Semiconductor. The datasheet is for reference information only.