

SPECIFICATION
FOR LITHIUM BATTERY
锂电池技术规范

Model: CR2450

Approved By (批准)	
Department (部门)	
Name (姓名)	
Title (标题)	
Signature/Date (签名/日期)	

(Remarks: The above table shall be filled by customer 上表须由客户填写)

Issued by (拟制):

Checked by (复核):

Approved by (批准):

Document number(文件编号): FAT/JF-JSCR-316

Version number (版次): A/0

DATE : 2019-01-02

WUHAN FANSO TECHNOLOGY CO.,LTD.

武汉孚安特科技有限公司

Rd.5,Sitai Industrial Park,Yongfeng Ave,Hanyang Dist,Wuhan China.

中国湖北省武汉市汉阳区永丰街四台工业园四台五路

TEL:027-84453199

FAX:027-84453116

<http://www.fansobattery.com>

PRODUCT SPECIFICATION

产品技术规范

1. Applicability:

(适用性)

This specification is applicable to the following product:

Coin type manganese lithium battery **CR2450**

本规范适用于以下产品：锂锰扣式电池 **CR2450**

2. Battery type and ratings:

(电池类型和等级)

2.1. **Battery type** (电池类型) : **CR2450**

2.2. **Nominal voltage** (标准电压) : **3.0V**

2.3. **Nominal capacity**: **600mAh** (on continuous discharge at 20°C under 7.5kΩ load to
(标准容量) 2.0V end-voltage, 20°C条件下负载 7.5kΩ连续放电至2.0V 终止)

2.4 **Outer dimensions**: Outer dimensions shall be as shown in Fig. 1, Battery Dimensions.
(外观尺寸) 外观尺寸见图1“电池尺寸”

2.5 **Mass** (包装重量) : **Approx. 6.9 g**

2.6 **Production country** (生产国家) : **China**

2.7 **Guarantee** (保质期) : **1 year**

2.8 **Terminals** (接线端) :

Materials of Positive electrode (正极材料) : SUS430/SUS430+Ni-plated

Negative electrode (负极材料) : SUS430/SUS430+Ni-plated

3. Quality requirements:

(质量要求)

3.1 **Dimensions**: Dimensions of batteries when tested in accordance with Subparagraph 4.4.1 shall be as shown in Fig. 1. Battery dimensions.

(尺寸：按4.4.1测试的电池尺寸应与图1“电池尺寸”相一致)

3.2 **Appearance**: Battery shall have no deformation, dent, stain, leakage and camber or burr on their sealing members, which may adversely affect their appearance, performance and commercial value. There shall be no coatings or other foreign objects on the surface of terminals which may adversely affect actual use or performance of batteries.

(外观：电池外观应无变形，无凹痕，无污点，无漏液，密封部件无拱形或毛边，以免影响其外观性能和商业价值。电池接线端应无覆盖物或异物，以免影响实际使用或电池性能)

3.3 **Characteristics** (特性) :

(1) **Open-circuit voltage**: Open-circuit voltage of batteries when tested in accordance with Subparagraph 4.4.3 shall meet the requirement set forth in Table 1.

(开路电压:按4.4.3测试的开路电压应与表1相一致)

(2) **Closed-circuit voltage**: Closed-circuit voltage of batteries when test in accordance with Subparagraph 4.4.4 shall meet the requirements set forth in Table 1.

(闭路电压:按4.4.4测试的闭路电压应与表1相一致)

[TABLE 1]

TEST ITEMS 测试项目	TEMPERATURE 温度	INITIAL 初期	AFTER 12 MONTHS 12个月后	REMARKS 备注
Open-circuit Voltage 开路电压	20±2°C	3.0V TO 3.4V	3.0V TO 3.4V	
Closed-circuit Voltage 闭路电压	20±2°C	3.0V TO 3.4V	3.0V TO 3.4V	Load Resistance 7.5kΩ . 0.8 Sec. 负载7.5kΩ电阻0.8秒

(3) Service life: Service life of batteries when tested in accordance with Subparagraph 4.4.5 shall meet the requirements set forth in Table 2.

(使用寿命: 按4.4.5测试的使用寿命应与表2相一致)

[TABLE 2]

TEST ITEMS 测试项目	TEMPERATURE 温度	INITIAL 初期	AFTER 12 MONTHS 12个月后	REMARKS 备注
Service Life 使用寿命	20±2°C	1400 Hrs. Or Longer ≥1400小时	1372 Hrs. or Longer ≥1372小时	Continuous Discharge Under 7.5kΩ Load to 2.0V End-Voltage 负载7.5kΩ连续放电至2.0V终止

(4) Service life after storage at high temperature: Service life of batteries when tested in accordance with Subparagraph 4.4.6 shall meet the requirements set forth in Table 3

(高温储存后使用寿命: 按4.4.6测试的使用寿命应与表3相一致)

[TABLE 3]

TEST ITEM 测试项目	STORAGE TEMP 储存温度	STORAGE PERIOD 储存期	REQUIREMENT 要求	REMARKS 备注
Service Life After Storage At High Temperature 高温储存后使用寿命	60 ±2°C	20 Days	1372Hrs Minimum ≥1372小时	Continuous Discharge At 20±2°C Under 7.5kΩ Load To 2.0V End-Voltage After Storage. 储存后, 20±2°C条件下负载7.5kΩ连续放电至2.0V终止

(5) Leakage characteristics: Batteries when tested in accordance with Subparagraph 4.5.1 shall have no leakage.

(漏液特性: 按4.5.1测试的电池应与表4相一致 (无漏液))

[TABLE 4]

TEST ITEM 测试项目	REQUIREMENT 要求	TEST CONDITIONS 测试条件
Leakage Characteristics 漏液特性	No Leakage 无漏液	Temperature: 45 ± 2°C, Relative Humidity: 75% Storage: 30 Days Shall Be Inspected By Visual Means 温度: 45 ± 2°C, 相对湿度: 低于75% 储存: 30天 视觉检查

(6) Self-discharge: Self-discharge of batteries when tested in accordance with Subparagraph 4.5.2 shall be as set forth in Table 5.

(自放电: 按4.5.2测试的自放电应与表5相一致)

[TABLE 5]

TEST ITEM 测试项目	REQUIREMENT 要求	TEST CONDITIONS 测试条件
Self-discharge 自放电	2% or Below 2% 或以下	Continuous Discharge Under 7.5kΩ Load To 2.0V End-voltage After 12 Months Storage At 20°C. (To Obtain From The Mean Value Of The Same Lot) 20°C条件下储存12个月后负载7.5kΩ 连续放电至 2.0V 终止。 (取平均值)

4. Testing:

(测试)

4.1 Test conditions (测试条件) :

4.1.1 Initial test :Initial test must be done within 1 months from delivery

(初期测试:初期测试应在交付后一个月内进行)

4.1.2 Temperature and humidity: Unless otherwise specified elsewhere, tests shall be conducted at ordinary temperature (20±2°C) and ordinary humidity (55±20%RH).

(温度和湿度: 除非另有说明, 测试应安排在常温 (20±2°C) 和正常湿度 (55±20%RH)的环境中)

4.2 Storage of test specimen batteries (测试样品电池的储存) :

4.2.1 Specimen batteries to be tested shall be kept at the ambient temperature of 25°C or below and at the relative humidity of 75% or below.

(待测的样品电池应在环境温度25°C 或以下, 相对湿度75% 或以下的环境中保存)

4.2.2 Storage at less than -20°C can deform the plastic parts and may cause a leakage.

(在低于-20°C 储存会使塑料部件变形, 导致漏液)

4.2.3 To prevent self-discharge caused by corrosion or decrease of insulation, humidity during storage shall be less than75%RH without dewing on battery.

(以防因腐蚀或绝缘材料减少引起的自放电, 储存的湿度应低于75%RH 不至于电池结露)

4.3 Measuring instruments and devices (测量仪器与装置) :

4.3.1 Dimensions: Outer micrometers specified inJIG26-95, dial gauges specified in JIS B 7503, and vernier callipers specified in JJG30-92 or those having equal or better accuracy shall be used.

(尺寸: JJG26-95中指定的千分尺, JIS B 7503中指定的百分表, JJG30-92 中指定的游标卡尺或等效或更精确的仪器)

4.3.2 DC voltmeters: The tolerance shall be ±0.01V and the input resistance rating shall be 10MΩ or more. (直流电压表: 公差应在±0.01V, 输入电阻极限为10MΩ或更大)

4.3.3 Load resistance: Load resistance shall include resistance throughout external circuits, and its tolerance shall be ±0.5%.

(负载电阻: 负载电阻应包含贯穿外部电路的电阻, 公差应在±0.5%)

4.4 Test methods (测试方法) :

4.4.1 Dimensions: Dimension shall be measured with instruments specified in Subparagraph

4.3.1 above, provided that either one or both sides of such instruments shall be insulated in measuring the overall height of the batteries.

(尺寸: 尺寸应用上面4.3.1指定的工具测量。工具的一边或两边在测试电池总高时应被绝缘)

4.4.2 Appearance: Appearance of batteries shall be inspected by visual means.

(外观: 电池外观应通过视觉检查)

4.4.3 Open-circuit voltage: Test specimen batteries shall be kept for 8 hours or longer at the ambient temperature specified in Table 1, and then the voltage between both terminals shall

be measured at the same ambient temperature with a voltmeter as specified in Subparagraph 4.3.2.

(开路电压：测试样本电池应在表1中指定的环境温度中储存8小时或以上，然后在同一环境温度中用4.3.2指定的电压表测试两端电压)

4.4.4 Closed-circuit voltage: Test specimen batteries shall be kept for 8 hours or longer at the ambient temperature specified in Table 1. and then the voltage between both terminals shall be measured with a voltmeter as specified in Subparagraph 4.3.2 while the specified load is connected between both terminals at the same ambient temperature as specified above; provided that the measured value shall be based on meter reading taken 0.8 seconds after the circuit is closed.

(闭路电压：测试样本电池应在表1中指定的环境温度中储存8小时或以上，然后在同一环境温度中用4.3.2指定的电压表测试两端电压，同时规定负载应按照上面指定在同一环境温度中连接电池两端,提供的测量值应基于闭路后0.8秒内读取的仪表读数)

4.4.5 Service life: Test specimen batteries shall be kept for 8 hours or longer at the ambient temperature specified in Table 2. and shall then be continuously discharged at the same ambient temperature and through the specified load resistance. The discharge shall be continued until the terminal voltage of the test specimens falls below the discharge end-point voltage of 2.0V, and the time during which the terminal voltage has been maintained equal to and above the discharge end-point voltage shall be taken as the service life.

(使用寿命：测试样本电池应在表2中指定的环境温度中储存8个小时或以上，然后在同一环境温度中连接规定负载电阻连续放电。放电应是连续的直到测试样本的路端电压降到放电终止电压2.0V，路端电压维持在等于或高于放电终止电压的时间即是使用寿命)

4.4.6 Service life after high-temperature storage: Test specimen batteries, after having been stored at the temperature and period specified in Table 3, shall be kept for 12 hours or longer at ordinary temperature ($20\pm 2^{\circ}\text{C}$) and at ordinary humidity ($55\pm 20\%\text{RH}$) and shall then be continuously discharged through the load resistance $7.5\text{k}\Omega$ at ambient temperature of $20\pm 2^{\circ}\text{C}$. The discharge shall be continued until the voltage falls below the discharge end-point voltage of 2.0V, and the time during which the voltage has been maintained equal to and above the discharge end-point voltage shall be taken as the service life.

(高温储存后使用寿命：测试样本电池在表3中指定的温度和时期储存后应在常温($20\pm 2^{\circ}\text{C}$) 正常湿度($55\pm 20\%\text{RH}$)环境中储存12个小时或以上，然后在 $20\pm 2^{\circ}\text{C}$ 的环境温度中连接 $7.5\text{k}\Omega$ 负载电阻连续放电。放电应连续直到电压降到放电终止电压2.0V，电压维持在等于或高于放电终止电压的时间即是使用寿命)

4.5 Other tests (其它测试) :

Tests specified below shall be conducted as required. Except as specified in this paragraph. Test methods be in accordance with the provisions of Paragraph 4.4.

(下面指定的测试应按需要进行。除非本段指定，测试方法与4.4相一致)

4.5.1 Electrolyte leakage test: Test specimen batteries shall be examined for electrolyte leakage while they are kept at ordinary temperature and at ordinary humidity after having been stored at the temperature, humidity and period specified in Table 4.

(电解液漏液检测：测试样本电池在表4中指定的温度、湿度和时期储存后在常温和正常的湿度下储存时检测其电解液漏液与否)

4.5.2 Self-discharge: Test specimen batteries which have been stored for 12 month at the ambient temperature of $20\pm 2^{\circ}\text{C}$ and at the relative humidity of $55\pm 20\%$ shall be tested for service life in accordance with the method specified in Subparagraph 4.4.5

(自放电：测试样本电池在环境温度 $20\pm 2^{\circ}\text{C}$ 和相对湿度 $55\pm 20\%$ 的环境中储存12个月，应按照4.4.5中指定的方法测试其使用寿命)

Self-discharge shall be determined in the following manner:

(自放电应在以下公式中确定)

$$\text{Self-discharge rate (\%)} = \frac{X1 - X2}{X1} \times 100\%$$

$$\text{自放电率 (\%)} = \frac{X1 - X2}{X1} \times 100\%$$

X1: Average initial discharge life of batteries of the same lot

X1: 同一批电池的平均初始放电寿命

X2: Average discharge life after storage

X2: 储存后平均放电寿命

4.6 Important Notes(Warranty) 重要事项 (担保)

4.6.1 The batteries are warranted to conform to the description contained in this specifications for a period of twelve(12) months from the ex-factory date and any claim by customer (apparatus manufacturer or distributor) must be made within such period. During that warranty period, if the batteries are proved to become defective, non-defective and conforming batteries will be supplied in due course at sole expense of Fanso upon Fanso's own determination that this is apparently caused by negligence of Fanso.

(电池在工厂交货日期12个月内保证符合本规范中所含描述, 任何来自客户(仪器制造商或批发商)的要求必须在此期间完成。在保证期内, 如果电池被证明有缺陷, 或者无缺陷但不符合要求的电池, 费用由孚安特单独承担)

4.6.2 This product, if defective in materials or workmanship, will be replaced free of charge, when returned to Wuhan Fanso Technology CO.,Ltd. Replacement is the sole obligation under this warranty. This warranty expressly excludes incidental and consequential damages caused by use of, or inability to use, this product.

(产品若有材料或工艺缺陷, 在退回到武汉孚安特科技有限公司时将被免费更换。更换在保证期内是孚安特单独的责任。这里的保证, 不包括因使用或间接使用本产品而造成附属、从属损害)

4.6.3 When customer does any work on the battery except instructions in this specifications, for example wire is soldered to the tab or battery surface directly, Wuhan Fanso Technology CO.,Ltd. Can not warrant any battery performance including safety and the customer shall undertake the responsibility of all damage caused by this battery.

(当客户在本规范规定的操作指南之外对电池采取其它任何动作, 例如在电池表面直接焊线, 武汉孚安特科技有限公司不保证电池安全等性能, 同时客户应承担所有应此电池而引起的损害责任)

4.6.4 Confirm and assure the matching and reliability of batteries on actual set or unit application with customer's responsibility

(确保在实际使用或设备应用中使用相匹配和可靠的电池, 以对客户负责)

4.6.5 In the case of the following situation, it will be assured that Wuhan Fanso Technology CO.,Ltd. dose not take responsibility

(就以下情况来说, 武汉孚安特科技有限公司将不承担责任)

- (1) When the appropriate handling, use, installation, or examination of batteries were not carried out. (没有进行恰当的操作、使用、安装或检查电池)
- (2) When the instructions, attentions or warning mentioned in this specification were not followed. (没有遵循本规范中提到的操作指南, 注意或警告)

(3) When the rational instructions or advice of Wuhan Fanso Technology CO.,Ltd. were not followed. (没有遵循武汉孚安特科技有限公司提出的指示或劝告)

4.6.6 When this specifications is not returned in 6 months from issued date. This specification is deemed to be. (当本规范自发行日起6个月内没有返回, 本规范将被认为生效)

5. Markings:

(标签)

5.1 Markings on batteries (电池上标签) :

5.1.1 Battery type (电池类型) : CR2450

5.1.2 Brand of battery (电池品牌) : FANSO

5.1.3 Polarity (极性) : + [(-) shall not be indicated] (+ [(-) 不标识])

5.1.4 Manufacturing marks (制造标识) : The year and month of production shall be marked on the negative (-) terminal side (生产年月应在负极面(-)标识)

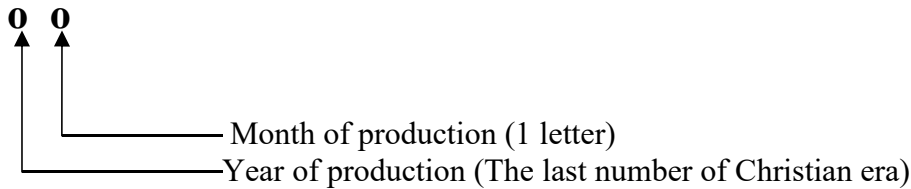

[[Example] 81..... Manufactured in January 2018

8X Manufactured in October 2018

8Y Manufactured in November 2018

8Z Manufactured in December 2018

Month of production.

- January to September -- 1- 9

- Oct, Nov, Dec, -----X, Y, Z

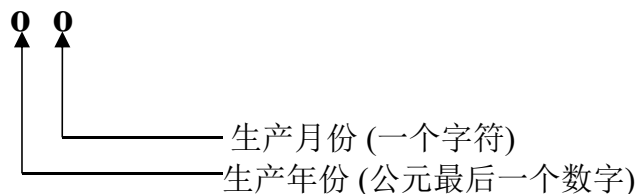

[举例] 81 2018年1月制造

8X 2018年10月制造

8Y 2018年11月制造

8Z 2018年12月制造

生产月份

-1月~9月 -- 1- 9

RATINGS OF MANGANESE DIOXIDE LITHIUM BATTERY

锂-二氧化锰电池等级

(TYPE: CR2450)

CLASSIFICATION 分类		MANGANESE DIOXIDE LITHIUM PRIMARY BATTERY 锂-二氧化锰电池
BATTERY SYSTEM 电池体系		COIN TYPE MANGANESE DIOXIDE LITHIUM BATTERY 锂-二氧化锰扣式电池
BATTERY TYPE 电池型号		CR2450
NOMINAL VOLTAGE 标准电压		3.0V
NOMINAL CAPACITY 标准容量		600mAh (ON CONTINUOUS DISCHARGE UNDER 7.5kΩ load to 2.0V end-point) (负载 7.5kΩ 连续放电至2.0V终止)
STANDARD DISCHARGE CURRENT 标准放电电流		0.4mA
MASS 重量		APPROX. 6.9g
TERMINALS 接线端	CAP TERMINAL 正极壳 CASE TERMINAL 负极盖	SUS430/SUS430+Ni-plated SUS430/SUS430+Ni-plated
OUTER DIMENSIONS 外观尺寸	DIAMETER 直径 OVERALL HEIGHT 总高	φ24.5(+0/-0.3)mm 5.0(+0/-0.3)mm
USABLE TEMPERATURE RANGE 使用温度范围		-20°C~+70°C
STORAGE TEMPERATURE RANGE 储存温度范围		0°C~30°C
STORAGE HUMIDITY RANGE 储存湿度范围		35%~75%

The Appearance Of CR2450

外观



The Dimensions Of CR2450

尺寸

Fig.1

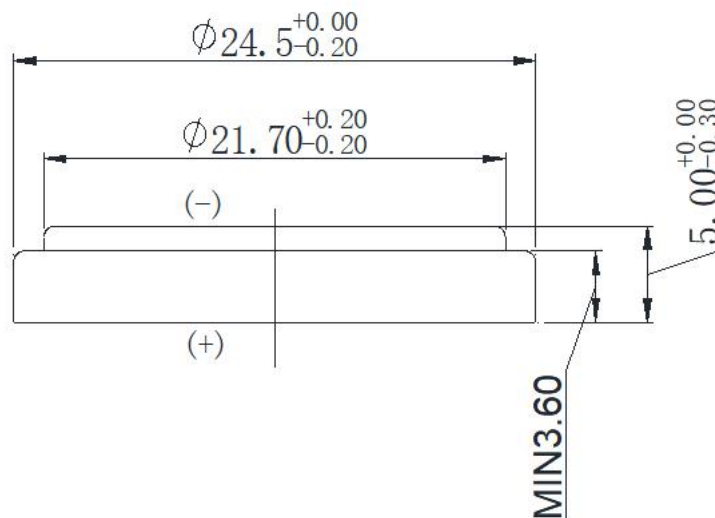

Lithium manganese dioxide battery

CR2450

Specifications

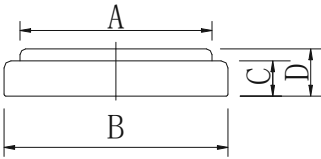
Nominal Voltage	3V	Dimensions (mm) 	A	$\phi 21.7$
Nominal Capacity	600 (mAh)		B	$\phi 24.5^{+0.0}_{-0.2}$
Continuous standard load	7.5 (K Ω)		C	3.60 (Ref.)
Operating temperature	-20~70°C		D	$5.0^{+0.0}_{-0.3}$
Weight	6.9 (g)			

Discharge characteristics

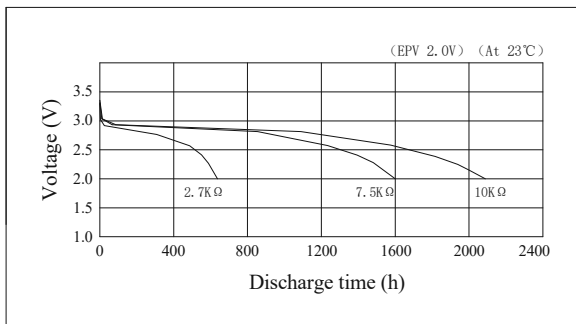

Temperature characteristics

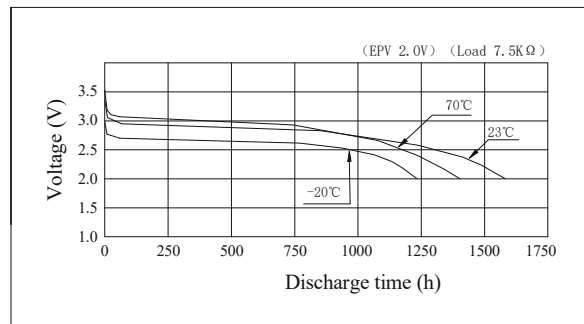

Load vs. Operating voltage

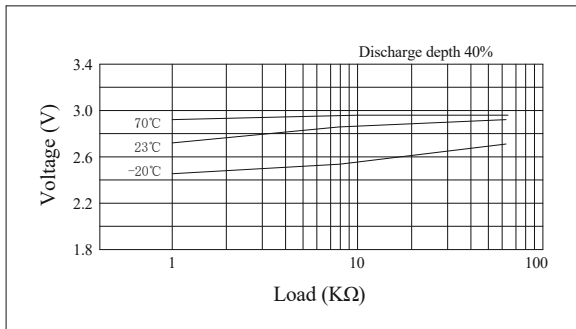

Load vs. Capacity

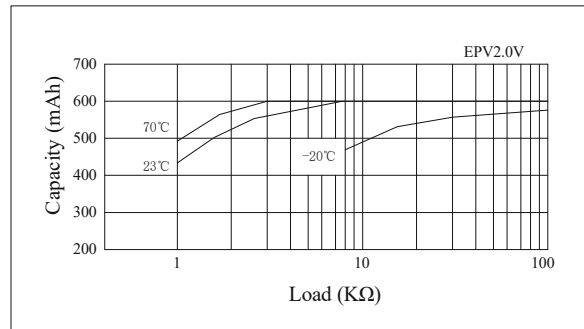

Pulse discharge characteristics

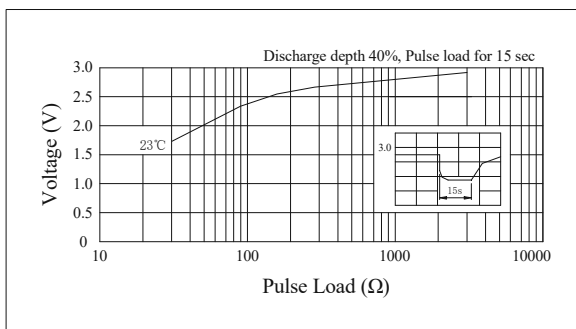

Storage characteristics

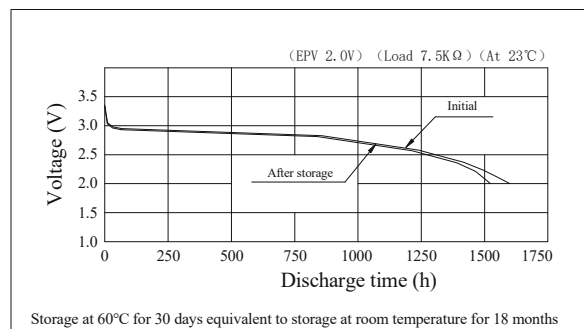

6. Precautions

(注意事项)

●Precautions in Designing (设计注意事项)

To use the battery efficiently, observe the following precautions.
(为有效地使用电池, 请遵循以下注意事项)

1. Confirm the standard discharge current surely when batteries are used.
(使用电池时确认好标准放电电流)

※This battery is not for heavy loading discharge.
(电池未加重负载放电)

Model 型号	Standard discharge current 标准放电电流
CR1025	0.1mA
CR1220	0.1mA
CR1620	0.1mA
CR1632	0.2mA
CR2016	0.1mA
CR2025	0.2mA
CR2032	0.2mA
CR2354	0.4mA
CR2430	0.2mA
CR2450	0.4mA
CR2477	0.6mA
CR3032	0.4mA

2. Usage as main power source (用作主电源)

(1)Selection of battery (电池的选择)

Select the most appropriate battery considering the electric property of equipment.
(考虑设备的电性, 选择最合适的电池)

(2)A number of use batteries and usage (多个电池及其使用)

Keep under 3 batteries to use for Lithium coin battery.

Do not mix any different brands when some batteries are used together.

Set in a battery charge protection equipment when it is used connecting in parallel.

(多个锂锰扣式电池同时使用时应控制在3个以下。当一些电池一起使用时, 请勿混乱不同品牌。当并行连接使用时, 请加电池充电保护装置)

(3)Circuit design (电路设计)

Set apart battery circuit from other power circuits.

Set in a fuse or something safe parts in a circuit

(将电池电路与其它动力电路分开。在电路中加入保险丝或其它保险部件)

3. Use as auxiliary power (用作辅助电源)

(1)Circuit design (电路设计)

Keep the circuit individually preventing being charged or forced discharge by main power source. (确保电路的独立性, 以防被主电源充电或强制放电)

(2)Circuit design (for back-up memory) 电路设计(备份存储器)

Set up a Diode and protection circuit to prevent being charged to a battery when a battery is connected to main power source circuit.

(建立二极管保护电路, 以防当电池与主电源连接时电池被充电)

■Precautions in Designing a Memory Backup Circuit

备份存储器电路设计注意事项

A primary lithium battery is not rechargeable.

When used for memory backup in combination with another power source, current may flow into the battery from the other source. To prevent this, include a protection diode and resistor in the circuit so that no battery charging or over discharging can occur.

Allowable Range of Diode Back-Leakage Current

To prevent the battery from being charged by the main power source, be sure to use a back-current prevention diode and a protection resistor. Select a silicon diode or a Schottky diode with minimum leakage current, and design the circuit so that the amount of charging due to leakage current does not exceed 1% of the nominal battery capacity over the total period of use. (锂电池组不可充电。)

(当使用于备份存储器时与其它电源联合，电流可能会从其它电源流入电池。为阻止其发生，在电路中加入保护二极管和电阻器，那么电池充电和过放电将可避免。

返回的泄露电流在二极管允许范围内。

为阻止电池被主电源充电，务必使用逆流保护二极管和保护电阻器。选择低值泄露电流的硅二极管或肖特基二极管，设计电路以致电池使用全程中由于泄露电流损失的量不超过电池标准容量的1%)

[Backup Circuit Example 备份电路例子]

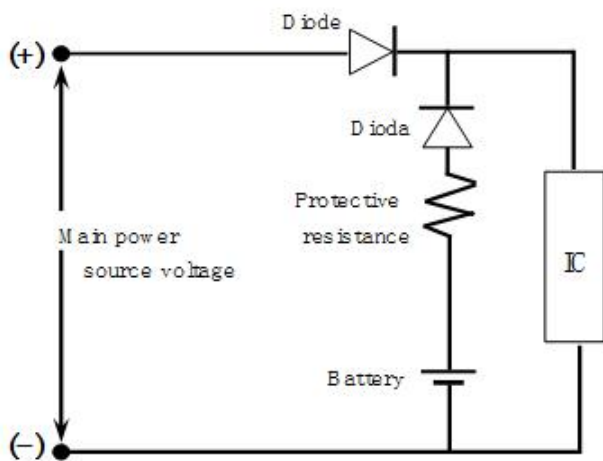

Back-current Prevention Diode and Protection Resistor Used

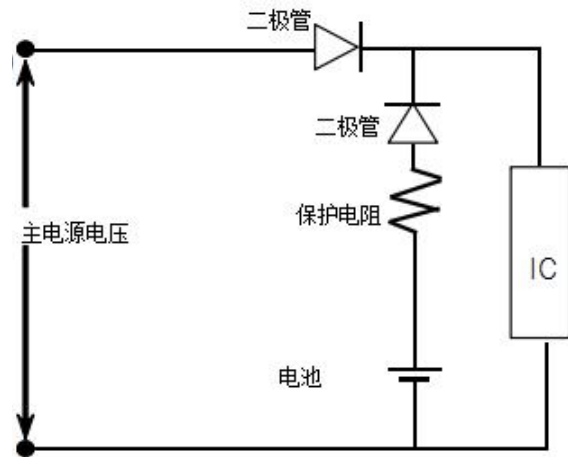

逆流保护二极管和保护电阻应用

■Maximum Allowable Charge Current to Battery

电池最大允许充电电流

A protection resistor is needed to prevent diode failure from allowing a large current to flow into the battery. The following table shows the maximum allowable charging current in the event of diode failure.

(保护电阻器用于阻止因二极管失效而导致大电流流入电池。以下表中列出万一二极管失效时最大允许充电电流)

Model 型号	Maximum allowable charging current 最大允许充电电流
CR1025	2.5mA
CR1220	2.5mA
CR1620	2.5mA
CR1632	2.5mA
CR2016	10mA

CR2025	10mA
CR2032	10mA
CR2354	10mA
CR2430	15mA
CR2450	15mA
CR2477	15mA
CR3032	15mA

[How to Calculate Protection Resistance R] (如何估算保护电阻R值)

Protection resistance R must exceed the value calculated in the following formula:

(保护电阻R值应超过以下公式估算的值)

$$R \geq \frac{V(\text{Main power source voltage})}{I(\text{Maximum allowable charge current per battery})}$$

※In this equation, the worst-case battery voltage (0) is assumed.

$$R \geq \frac{V(\text{主电源电压})}{I(\text{每个电池最大允许充电电流})}$$

※在这个方程式中，假定最坏电池电压为0V

4. Battery holder and battery chamber (电池座和电池室)

(1)Design a battery chamber which the electric is not connected when a battery was reversed.

Describe the correct loading direction of battery surely and indelibly on a battery chamber.

(设计电池室以防因电池颠倒而引起的电流不通。描绘电池正确的加载方向于电池室里，确保其无疑并不可磨灭)

(2)Design a battery chamber which other size batteries can not be inserted or connected.

(设计的电池室应无法嵌入或连接其它不同型号的电池)

(3)Design a battery chamber which is outgassed easily. (设计的电池室应易通气)

(4)Design a battery chamber preventing water entering. (设计的电池室应防水)

(5)Add the feature of explosion protection to a battery chamber when it is sealed.

(电池室密封时应增加防爆功能的装置)

(6)Set a battery chamber apart from heat source equipment.

(设计的电池室应远离热源设备)

(7)Design a battery chamber which children can not pull out easily.

(设计的电池室小孩应不易拔出)

5. Interface and terminal (交界面和接线端)

(1)Make sufficient quality and shape for electric connection.

(为电连接确保足够的质量和形状)

(2)Design an attached circuit which prevents the batteries reversed.

(设计附属电路以防电池颠倒)

(3)Shape the battery preventing from being reversed. (设计电池形状以防其被颠倒)

(4)Do not solder or weld to batteries directly. (切勿直接焊接电池)

6. List the precautions (注意事项列表)

(1)Main body (机身)

Specify the loading direction of battery on battery chamber.

(在电池室内明确说明电池的加载方向)

(2)Manual (指南)

List the precautions how to handle batteries. (列出如何操作电池的预防措施)

7. Do not solder the battery directly. Excessive heating may cause deformation of the battery components such as the gasket, which may lead to the battery swelling, leakage, explosion or ignition. (切勿直接焊接电池。过热会造成电池构件变形, 例如密封胶圈的变形可能导致电池膨胀, 漏液, 爆炸或着火)
8. Observe the soldering condition for the tabbed battery to be specified by the manufacturer. Choose the tabbed battery if soldering is required. Excessive heating may cause deformation of the gasket, leakage or performance deterioration of the battery. Assure not to exceed the battery temperature higher than 70°C at soldering. (遵循制造商指定的标签电池的焊接条件。如果需要焊接, 请选择标签电池。过热会造成密封胶圈变形, 漏液或电池性能退化。确保焊接时电池温度不超过70°C)
9. Use nickel-plated iron or stainless steel for the terminals that contact the battery. (使用镀镍的铁或不锈钢作为连接电池的接线端材料)
10. Make sure that terminal contact pressure is 100g minimum for stable contact. (确保在持续接触时, 接线端触点压力最低限度为100g)
11. Keep the battery contact terminal surfaces clean and free from moisture and foreign matter. (保持电池接触端点表面洁净, 没有水分和杂质)
12. Before inserting the battery, check the battery contact terminals to make sure they are normal, not bent or damaged. Bent terminals may not make good contact with the battery or may cause it to short-circuit. (在嵌入电池前, 检查电池接触端点确保他们是正常的, 没有弯曲或损害。弯曲的接线端可能导致无法良好地连接电池或引起短路)
13. Do not overdischarge the battery lower than 0V. It may lead to reversed polarity and cause ignition, heating, leakage or explosion. (电池切勿过放电至低于0V。它可能导致反极性, 引起着火, 变热, 漏液或爆炸)
14. Lithium Manganese Dioxide Battery that is almost exhausted still maintains high output voltage that is almost the same as that of a fresh battery. Avoid using a mixture of old and new batteries; replace all batteries in a set with new ones. (锂-二氧化锰电池耗尽时仍可保持高的输出电压, 几乎与新的电池无异。避免新旧电池混用, 请整套更换新电池)
15. Lithium Manganese Dioxide Battery requires considerable time to regain their normal voltage after even a slight short-circuit. Therefore, should the battery be short-circuited, wait an adequate time for the battery to recover before measuring its electrical characteristics. (锂-二氧化锰电池需要相当长的时间恢复到它们的正常电压即便是轻微短路。因此, 短路的电池在测量其电性能前, 需要足够的时间恢复)
16. Use a high impedance (1MΩ or higher) voltmeter to measure battery voltage. (使用高阻抗 (1MΩ or 以上) 电压表测量电池电压)
17. Battery characteristics vary with type and grade, even when batteries are the same size and shape. When replacing batteries with new ones, be sure to carefully check the symbols and numbers on each battery. (电池特性随型号和级别而变化, 即便是同样大小和形状。在更换新电池时, 务必仔细检查每个电池上的符号和数字)
18. Please design equipment so that infants cannot easily remove batteries and swallow them.

(请设计装备以致小孩不易移动和吞食)

19. Consult the sales representative, when series or parallel connection of several batteries is required. (如有必要多个电池串联或并联, 请咨询销售代表)

●Precautions for Mounting (安装注意事项)

Unlike other electronic components, Lithium Manganese Dioxide Battery(Coin-type) may be externally short-circuited before and after it is installed in circuit boards and without the power being turned on. This causes power drainage. As a result, the battery may lose its capacity before the equipment is even used. As short-circuits tend to occur in the following cases, please take care when handling the battery.

(不同其它电子零件, 锂-二氧化锰电池(扣式)在安装到电路板前后可能会外部短路, 同时动力未开启。这会造成动力流失。因此, 甚至在设备使用之前电池就可能会损失它的容量。例如短路发生在以下情况下, 请谨慎操作电池)

1. Overlapping Batteries (重叠电池)

Lithium Manganese Dioxide Battery is shaped as shown below. It has exposed positive(+)and negative(-) metallic surfaces with a thin cylindrical seal, called the gasket, inbetween them. When the batteries are overlapped or mixed together in a disorderly way, their positive(+)and negative(-)terminals touch each other, causing short-circuits. (锂-二氧化锰电池形状如下所示。它敞开的正极与负极间仅仅由一圈很窄的环状(密封圈)相隔离, 当电池杂乱地重叠堆放时, 它们的正极(+)和负极(-)端会相互接触而造成短路)

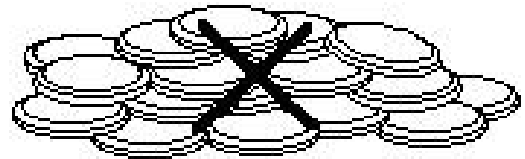
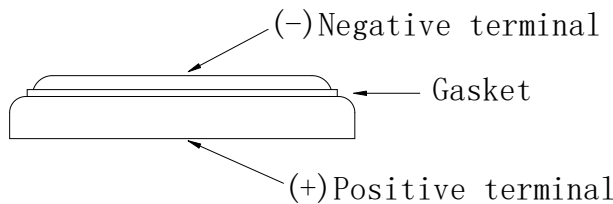

2. The Batteries Put in a Metallic Container or on a Metallic Plate

(将电池放入金属容器或金属盘里)

Similar to the overlapping battery problem, when the batteries are put in a metallic container or on a metallic plate, their positive(+)and negative(-)terminals may short-circuit through the conductive surface, depending on how the batteries are position.

(与重叠电池问题相似, 当电池放到金属容器或金属盘里, 它们的正极(+)和负极(-)端可能会通过导电性的表面和电池的位置而造成短路)

3. When The Battery is Held with Metallic Tweezers (当用金属镊子夹电池时)

When held with a pair of metallic tweezers as shown, the battery short-circuits through the tweezers. (当用一副金属镊子夹电池时, 电池通过金属镊子短路)

4. When The Battery Lead Plates Touch Each Other (当电池引线相互接触时)

When the battery lead plates bend and touch each other or other either terminal, the battery short-circuits. (当电池引线弯曲并相互接触或其它接线端接触时, 电池短路)

5. Solder Bridges (焊桥)

Solder may bridge between circuit board conductors, causing a short-circuit and draining the battery. (焊接可能桥连电路板导体, 造成短路, 耗尽电池)

6. Short-circuits through Soldering Irons (通过烙铁短路)

Similar to solder bridging, when the circuit board wiring is short-circuited by a soldering iron for an extended period the battery is drained and consumed. Complete short-circuits through

soldering irons within 5 seconds. (与焊桥相似, 当电路板线路被烙铁超时接触时引起短路, 电池能量将会流失并耗尽。通过烙铁短路应在5秒内结束)

7. Short-circuits through Piled Circuit Boards (通过堆叠的电路板短路)

When circuit boards with the batteries are piled on top of one another, their conductive traces may touch and form a battery discharge circuit that consumes the battery's power.

(当加载电池的电路板相互堆叠, 它们导电性的线路会接触而形成电池放电电路消耗电池能量)

8. Discharge through Conductive Electrostatic Prevention Mats

(通过导电的防静电垫短路)

Conductive mats are widely used to prevent static electricity from destroying semiconductors. If a circuit board with mounted battery is put on a conductive mat, the soldered conductors may touch the mat, providing a discharge path for the battery.

(导电垫广泛用于防止静电破坏半导体。如果安装电池的电路板放在导电垫上, 焊接的导体会接触到导电垫, 从而为电池提供了放电电路)

9. Improper Battery Mounting Polarity (不正确的电池极性安装)

When the battery's positive (+) and negative (-) terminals are reversed with respect to the battery mounting's polarity marks, the battery may be discharged, depending on the type of electric circuit. (当电池的正极(+)和负极(-)端相对电池极性安装标识而言颠倒安装时, 电池可能会因电路的类型而放)

10. Solder (焊接)

When the battery lead plates are dipped in a molten solder bath, the battery is temporarily short-circuited. Therefore, complete dipping within 5 seconds. (当电池引线金属片同时浸入软焊料浴中, 电池会暂时短路。因此, 浸渍应在5秒内完成)

● Handling Precautions (操作注意事项)

Please read and observe the following precautions thoroughly.

Lithium Manganese Dioxide Battery contains flammable materials, such as organic solvent. Improper battery handling may cause leakage, heating, explosion or ignition of the battery, which may lead to injury or product failure. (请彻底地阅读并遵循以下注意事项。)

(锂-二氧化锰电池含有易燃材料, 例如有机溶剂。操作电池不当会引起电池漏液, 发热, 爆炸或着火, 甚至会造成受伤或产品不合格)

<WARNING> <警告>

(1) Never charge the battery. Charging the battery may cause seethe of the battery electrolyte or increase of the battery internal pressure. Leakage, heating, explosion or ignition of the battery may be caused as a result of it. (切勿对电池充电。对电池充电会导致电池电解液沸腾或增加电池内部压力。正因如此, 可能会导致电池漏液, 发热, 爆炸或着火)

(2) Keep away from infants. If infant happens to swallow the battery, consult a doctor immediately. (远离小孩。如果发生小孩吞食, 请立即咨询医师)

(3) In case of eye contact with the battery electrolyte, immediately flush eyes thoroughly with water, and consult a doctor.

(万一电池电解液入眼, 立即用水彻底地冲刷眼睛并咨询医师)

(4) In case the battery electrolyte happen to come into mouth, gargle well enough and consult a doctor immediately. (万一电池电解液入口, 充分地漱口并立即咨询医师)

(5) Do not heat or disposed in fire or water. Do not modify or disassemble the battery. It may damage the gasket, and may cause ignition, heating, leakage or explosion.

(切勿加热或丢入火、水中处理。切勿改变或分解电池。这样做可能会破坏密封胶圈, 从而导致着火, 发热, 漏液或爆炸)

- (6) Do not short-circuit positive (+) and negative (-) terminals. Keep away from metal or other conductive materials. Jumbling the batteries of direct contact with positive (+) and negative (-) terminals and metal or other conductive materials may cause short.
(切勿让正极(+)、负极(-)端短路。远离金属或其它导电性的材料。把电池与金属或其它导电性的材料混在一起而使电池正极(+)、负极(-)端直接接触会导致电池短路)
- (7) When the battery is stored or disposed, isolate positive (+) and negative (-) terminals of the battery to avoid those terminals touch each other.
(当电池要被保存或处理，隔离电池的正极(+)、负极(-)端以免这些接线端相互接触)
- (8) Insert the battery with positive (+) and negative (-) terminals correctly oriented.
(按正确的正极(+)、负极(-)端方向嵌入电池)

<PRECAUTIONS> <防范>

- (1) Do not put the battery into microwave oven or drying machine.
(不要将电池放入微波炉或烘干机中)
- (2) Do not drop, apply excessive damage or deform the battery.
(不要跌落，使用过度损坏或变形的电池)
- (3) Do not mix the used battery together with the new battery or different type of batteries.
(不要与新电池或不同型号的电池混合使用)
- (4) Do not store the battery in high temperature and high humidity location and where the battery is exposed to sunlight to avoid performance deterioration, swelling or leakage, of the battery.
(不要将电池储存在高温高湿的场所或暴露于阳光下，以防电池性能退化，膨胀或漏液)