

**Round Type, FULL COLOR LED lamp**
**BL-L515**
**Features:**

- Ø 5mm Round Type , FULL COLOR LED lamp
- Ø Ultra brightness.
- Ø Choice of various viewing angles.
- Ø Diffused, Transparent and Water clear lens
- Ø IC compatible /Low current capability.
- Ø RoHs Compliance

**Electrical-optical characteristics: (Ta=25°C) (Test Condition: IF=20mA)**

Part Number	Chip			Lens Type	Forward Voltage(VF) Unit:V		Luminous Intensity (Iv) Unit:mcd		Viewing Angle 2θ/2 (deg)
	Emitted Color	Material	λ <sub>P</sub> (nm)		Typ	Max	Min.	Typ.	
					BL-L515RGBC-CA	Ultra Orange	AlGaInP	630	
	Ultra Pure Green	InGaN	525		3.80	4.50	2000	5000	
	Blue	InGaN	430		3.80	4.50	800	2000	
BL-L515RGBW-CA	Ultra Orange	AlGaInP	630	Water Diff.	2.10	2.50	200	500	30
	Ultra Pure Green	InGaN	525		3.80	4.50	300	600	
	Blue	InGaN	430		3.80	4.50	150	300	
BL-L515RGBC-CC	Ultra Orange	AlGaInP	630	Water Clear	2.10	2.50	800	2000	20
	Ultra Pure Green	InGaN	525		3.80	4.50	2000	5000	
	Blue	InGaN	430		3.80	4.50	800	2000	
BL-L515RGBW-CC	Ultra Orange	AlGaInP	630	Water Diff.	2.10	2.50	200	500	30
	Ultra Pure Green	InGaN	525		3.80	4.50	300	600	
	Blue	InGaN	430		3.80	4.50	150	300	

Note: -CC: common Cathode, -CA: common Anode

**Absolute maximum ratings (Ta=25°C)**

Parameter	UE	PG	UB	Unit
Forward Current I <sub>F</sub>	30	30	30	mA
Power Dissipation P <sub>d</sub>	65	110	120	mW
Reverse Voltage V <sub>R</sub>	5	5	5	V
Peak Forward Current I <sub>PF</sub> (Duty 1/10 @1KHZ)	150	150	100	mA
Operation Temperature T <sub>OPR</sub>	-40 to +80			°C
Storage Temperature T <sub>STG</sub>	-40 to +85			°C
Lead Soldering Temperature T <sub>SOL</sub>	Max.260±5°C for 3 sec Max. (1.6mm from the base of the epoxy bulb)			°C

Round Type, FULL COLOR LED lamp

BL-L515

Package configuration & Internal circuit diagram

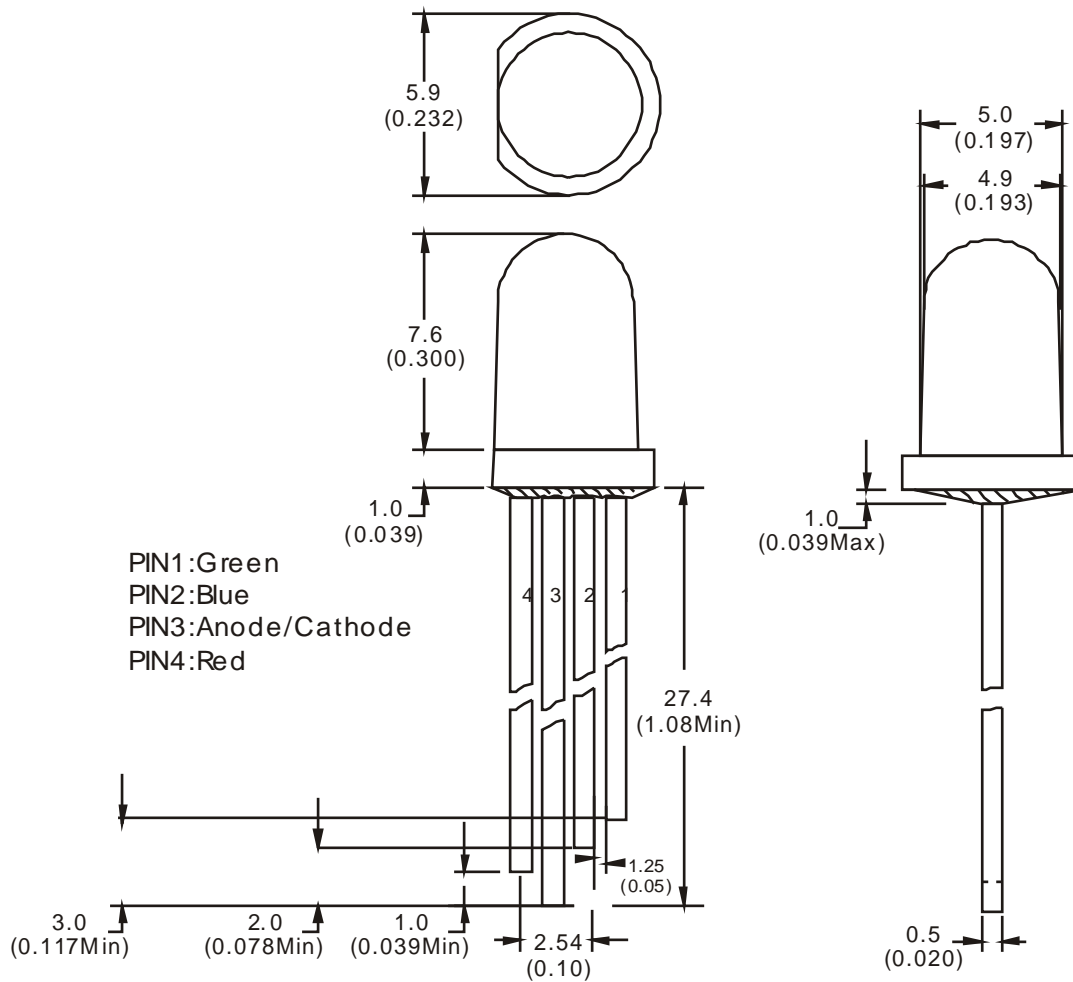

Notes:

1. All dimensions are in millimeters (inches)
2. Tolerance is  $\pm 0.25$  (0.01") unless otherwise noted.
3. Specifications are subject to change without notice.

**Round Type, FULL COLOR LED lamp**

**BL-L515**

**Typical electrical-optical characteristics curves:**

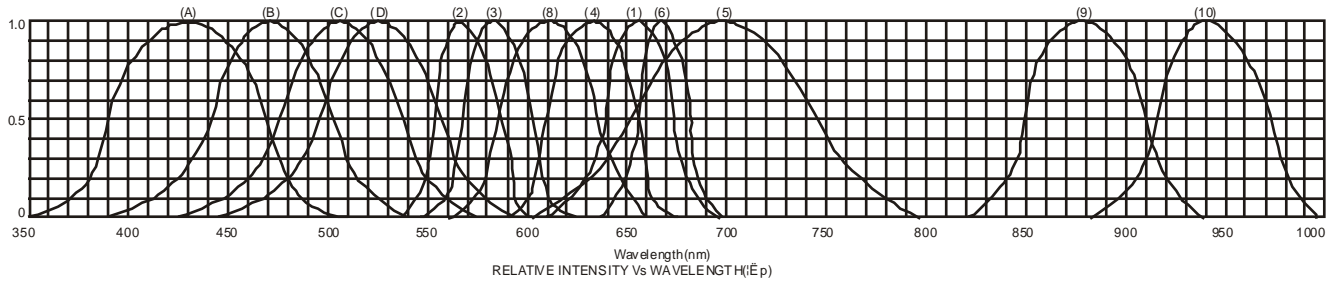

- (1) - GaAsP/GaAs 655nm/Red
- (2) - GaP 570nm/Yellow Green
- (3) - GaAsP/GaP 585nm/Yellow
- (4) - GaAsP/GaP 635nm/Orange & Hi-Eff Red
- (5) - GaP 700nm/Bright Red
- (6) - GaAlAs/GaAs 660nm/Super Red
- (8) - GaAsP/GaP 610nm/Super Red
- (9) - GaAlAs 880nm
- (10) - GaAs/GaAs & GaAlAs/GaAs 940nm
- (A) - GaN/SiC 430nm/Blue
- (B) - InGaN/SiC 470nm/Blue
- (C) - InGaN/SiC 505nm/Ultra Green
- (D) - InGaAlSiC 525nm/Ultra Green

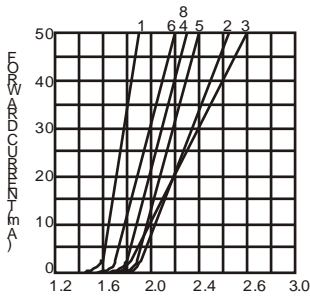

FORWARD VOLTAGE (Vf)  
FORWARD CURRENT VS.  
FORWARD VOLTAGE

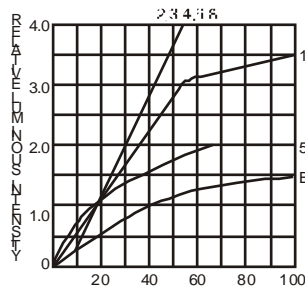

FORWARD CURRENT (mA)  
RELATIVE LUMINOUS  
INTENSITY VS. FORWARD  
CURRENT

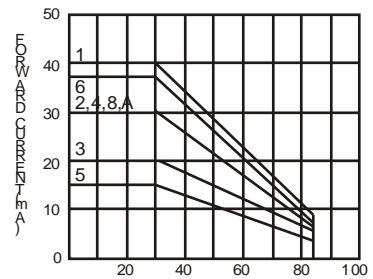

AMBIENT TEMPERATURE Ta ( )  
FORWARD CURRENT VS. AMBIENT  
TEMPERATURE



AMBIENT TEMPERATURE Ta ( )

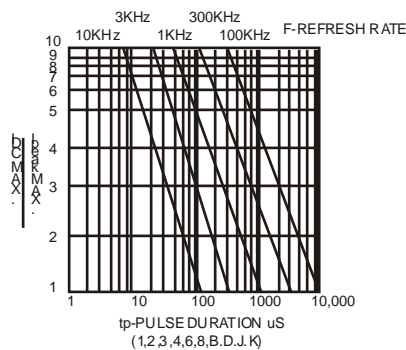

tp-PULSE DURATION µs  
(1,2,3,4,6,8,B,D,J,K)

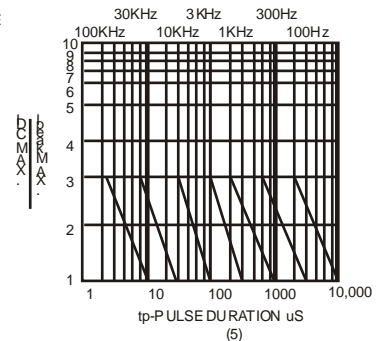

(5)

NOTE:25 free air temperature unless otherwise specified