

# CD4030B Types

## CMOS Quad Exclusive-OR Gate

High-Voltage Types (20-Volt Rating)

■ CD4030B types consist of four independent Exclusive-OR gates. The CD4030B provides the system designer with a means for direct implementation of the Exclusive-OR function.

The CD4030B types are supplied in 14-lead hermetic dual-in-line ceramic packages (F3A suffix), 14-lead dual-in-line plastic packages (E suffix), 14-lead small-outline packages (M, MT, M96, and NSR suffixes), and 14-lead thin shrink small-outline packages (PW and PWR suffixes).

### MAXIMUM RATINGS, Absolute-Maximum Values:

#### DC SUPPLY-VOLTAGE RANGE, ( $V_{DD}$ )

Voltages referenced to  $V_{SS}$  Terminal ..... -0.5V to +20V

INPUT VOLTAGE RANGE, ALL INPUTS ..... -0.5V to  $V_{DD}$  +0.5V

DC INPUT CURRENT, ANY ONE INPUT .....  $\pm 10$ mA

#### POWER DISSIPATION PER PACKAGE ( $P_D$ ):

For  $T_A = -55^\circ\text{C}$  to  $+100^\circ\text{C}$  ..... 500mW

For  $T_A = +100^\circ\text{C}$  to  $+125^\circ\text{C}$  ..... Derate Linearly at 12mW/ $^\circ\text{C}$  to 200mW

#### DEVICE DISSIPATION PER OUTPUT TRANSISTOR

FOR  $T_A = \text{FULL PACKAGE-TEMPERATURE RANGE (All Package-Types)}$  ..... 100mW

OPERATING-TEMPERATURE RANGE ( $T_A$ ) .....  $-55^\circ\text{C}$  to  $+125^\circ\text{C}$

STORAGE TEMPERATURE RANGE ( $T_{stg}$ ) .....  $-65^\circ\text{C}$  to  $+150^\circ\text{C}$

#### LEAD TEMPERATURE (DURING SOLDERING):

At distance  $1/16 \pm 1/32$  inch ( $1.59 \pm 0.79$ mm) from case for 10s max .....  $+265^\circ\text{C}$

### Features:

- Medium-speed operation— $t_{pHL}$ ,  $t_{pLH} = 65$  ns (typ.) at  $V_{DD} = 10$  V,  $C_L = 50$  pF
- 100% tested for quiescent current at 20 V
- Standardized, symmetrical output characteristics
- 5-V, 10-V, and 15-V parametric ratings
- Maximum input current of  $1 \mu\text{A}$  at 18 V over full package-temperature range; 100 nA at 18 V and  $25^\circ\text{C}$
- Noise margin (over full package-temperature range):

1 V at  $V_{DD} = 5$  V

2 V at  $V_{DD} = 10$  V

2.5 V at  $V_{DD} = 15$  V

- Meets all requirements of JEDEC Tentative Standard No. 13B, "Standard Specifications for Description of 'B' Series CMOS Devices"

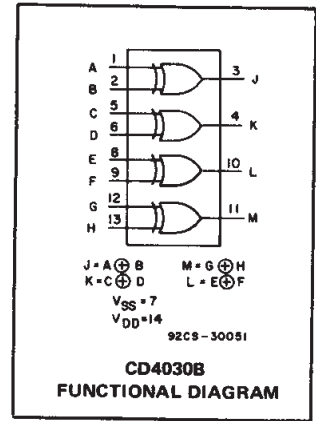

CD4030B  
FUNCTIONAL DIAGRAM

### Applications:

- Even and odd-parity generators and checkers
- Logical comparators
- Adders/subtractors
- General logic functions

### TERMINAL DIAGRAM

Top View

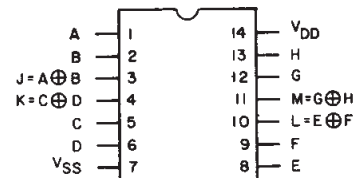

TOP VIEW 92CS-24473RI

### RECOMMENDED OPERATING CONDITIONS

For maximum reliability, nominal operating conditions should be selected so that operation is always within the following ranges:

| CHARACTERISTIC  | LIMITS |      | UNITS |
|---|--------|------|-------|
|   | MIN.   | MAX. |       |
| Supply-Voltage Range (For $T_A = \text{Full Package Temperature Range}$ ) | 3      | 18   | V     |

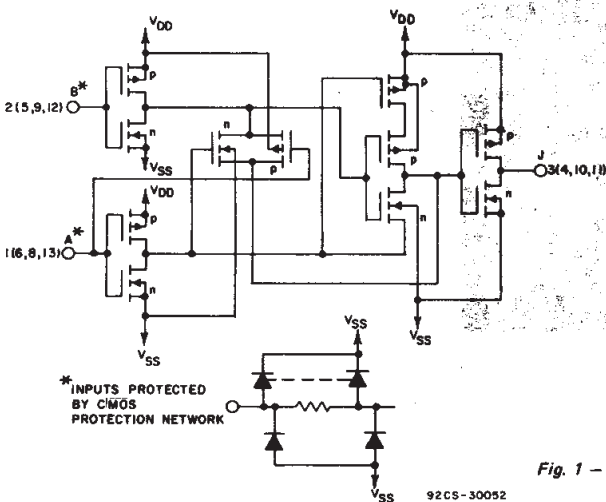

### TRUTH TABLE FOR ONE OF FOUR IDENTICAL GATES

| A | B | J |
|---|---|---|
| 0 | 0 | 0 |
| 1 | 0 | 1 |
| 0 | 1 | 1 |
| 1 | 1 | 0 |

1 = HIGH LEVEL  
0 = LOW LEVEL

Fig. 1 - Schematic diagram (1 of 4 identical gates).

# CD4030B Types

## STATIC ELECTRICAL CHARACTERISTICS

| CHARACTERISTIC                                     | CONDITIONS         |                     |                     | LIMITS AT INDICATED TEMPERATURES (°C) |       |       |       |       |                   |      | UNITS |
|--|--------------------|---------------------|---------------------|---------------------------------------|-------|-------|-------|-------|-------------------|------|-------|
|  | V <sub>O</sub> (V) | V <sub>IN</sub> (V) | V <sub>DD</sub> (V) | -55                                   | -40   | +85   | +125  | +25   |                   |      |       |
|  |                    |                     |                     |                                       |       |       |       | Min.  | Typ.              | Max. |       |
| Quiescent Device Current, I <sub>DD</sub> Max.     | —                  | 0,5                 | 5                   | 0.25                                  | 0.25  | 7.5   | 7.5   | —     | 0.01              | 0.25 | μA    |
|  | —                  | 0,10                | 10                  | 0.5                                   | 0.5   | 15    | 15    | —     | 0.01              | 0.5  |       |
|  | —                  | 0,15                | 15                  | 1                                     | 1     | 30    | 30    | —     | 0.01              | 1    |       |
|  | —                  | 0,20                | 20                  | 5                                     | 5     | 150   | 150   | —     | 0.02              | 5    |       |
| Output Low (Sink) Current I <sub>OL</sub> Min.     | 0.4                | 0,5                 | 5                   | 0.64                                  | 0.61  | 0.42  | 0.36  | 0.51  | 1                 | —    | mA    |
|  | 0.5                | 0,10                | 10                  | 1.6                                   | 1.5   | 1.1   | 0.9   | 1.3   | 2.6               | —    |       |
|  | 1.5                | 0,15                | 15                  | 4.2                                   | 4     | 2.8   | 2.4   | 3.4   | 6.8               | —    |       |
| Output High (Source) Current, I <sub>OH</sub> Min. | 4.6                | 0,5                 | 5                   | -0.64                                 | -0.61 | -0.42 | -0.36 | -0.51 | -1                | —    | mA    |
|  | 2.5                | 0,5                 | 5                   | -2                                    | -1.8  | -1.3  | -1.15 | -1.6  | -3.2              | —    |       |
|  | 9.5                | 0,10                | 10                  | -1.6                                  | -1.5  | -1.1  | -0.9  | -1.3  | -2.6              | —    |       |
|  | 13.5               | 0,15                | 15                  | -4.2                                  | -4    | -2.8  | -2.4  | -3.4  | -6.8              | —    |       |
| Output Voltage: Low-Level, V <sub>OL</sub> Max.    | —                  | 0,5                 | 5                   | 0.05                                  |       |       |       | —     | 0                 | 0.05 | V     |
|  | —                  | 0,10                | 10                  | 0.05                                  |       |       |       | —     | 0                 | 0.05 |       |
|  | —                  | 0,15                | 15                  | 0.05                                  |       |       |       | —     | 0                 | 0.05 |       |
| Output Voltage: High-Level, V <sub>OH</sub> Min.   | —                  | 0,5                 | 5                   | 4.95                                  |       |       |       | 4.95  | 5                 | —    | V     |
|  | —                  | 0,10                | 10                  | 9.95                                  |       |       |       | 9.95  | 10                | —    |       |
|  | —                  | 0,15                | 15                  | 14.95                                 |       |       |       | 14.95 | 15                | —    |       |
| Input Low Voltage, V <sub>IL</sub> Max.            | 0.5, 4.5           | —                   | 5                   | 1.5                                   |       |       |       | —     | —                 | 1.5  | V     |
|  | 1,9                | —                   | 10                  | 3                                     |       |       |       | —     | —                 | 3    |       |
|  | 1.5, 13.5          | —                   | 15                  | 4                                     |       |       |       | —     | —                 | 4    |       |
| Input High Voltage, V <sub>IH</sub> Min.           | 0.5, 4.5           | —                   | 5                   | 3.5                                   |       |       |       | 3.5   | —                 | —    | V     |
|  | 1,9                | —                   | 10                  | 7                                     |       |       |       | 7     | —                 | —    |       |
|  | 1.5, 13.5          | —                   | 15                  | 11                                    |       |       |       | 11    | —                 | —    |       |
| Input Current I <sub>IN</sub> Max.                 | —                  | 0,18                | 18                  | ±0.1                                  | ±0.1  | ±1    | ±1    | —     | ±10 <sup>-5</sup> | ±0.1 | μA    |

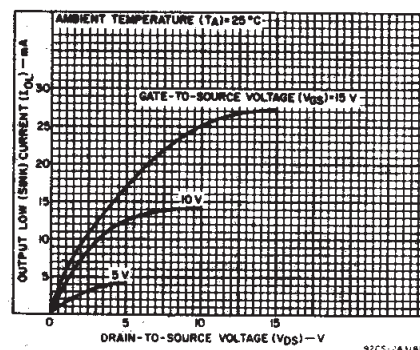

Fig. 2 - Typical output low (sink) current characteristics.

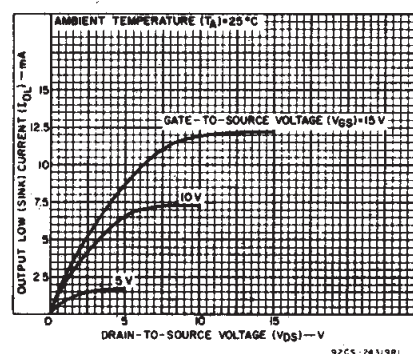

Fig. 3 - Minimum output low (sink) current characteristics.

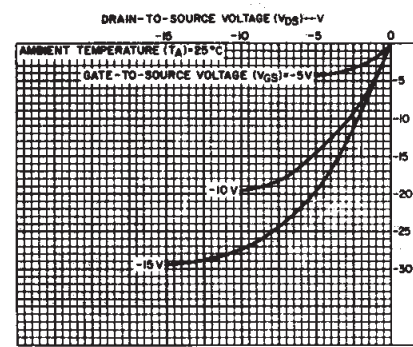

Fig. 4 - Typical output high (source) current characteristics.

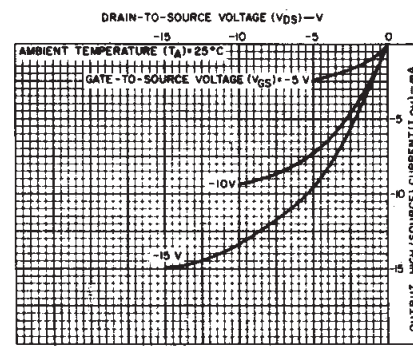

Fig. 5 - Minimum output high (source) current characteristics.

DYNAMIC ELECTRICAL CHARACTERISTICS at T<sub>A</sub> = 25°C; Input t<sub>r</sub>, t<sub>f</sub> = 20 ns, C<sub>L</sub> = 50 pF, R<sub>L</sub> = 200 KΩ

| CHARACTERISTIC  | CONDITIONS | LIMITS              |        | UNITS |      |
|---|------------|---------------------|--------|-------|------|
|   |            | V <sub>DD</sub> (V) | LIMITS |       |      |
|   |            |                     | Typ.   |       | Max. |
| Propagation Delay Time, t <sub>PLH</sub> , t <sub>PHL</sub> | Any Input  | 5                   | 140    | 280   | ns   |
|   |            | 10                  | 65     | 130   |      |
|   |            | 15                  | 50     | 100   |      |
| Transition Time, t <sub>THL</sub> , t <sub>TLH</sub>        | Any Input  | 5                   | 100    | 200   | ns   |
|   |            | 10                  | 50     | 100   |      |
|   |            | 15                  | 40     | 80    |      |
| Input Capacitance, C <sub>IN</sub>                          | Any Input  | 5                   | 7.5    | pF    |      |

COMMERCIAL CMOS HIGH VOLTAGE ICs

# CD4030B Types

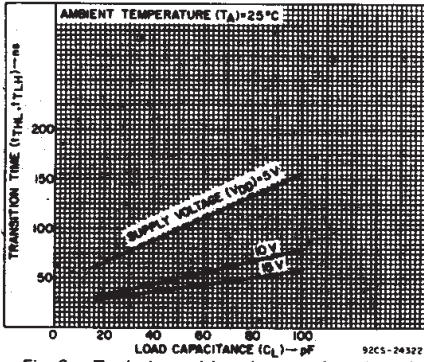

Fig. 6 - Typical transition time as a function of load capacitance.

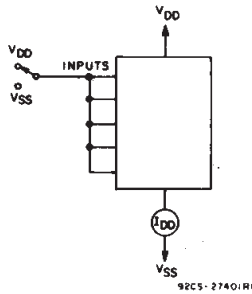

Fig. 10 - Quiescent-device current test circuit.

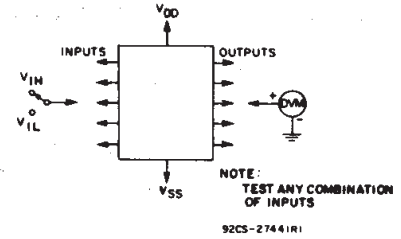

Fig. 11 - Input-voltage test circuit.

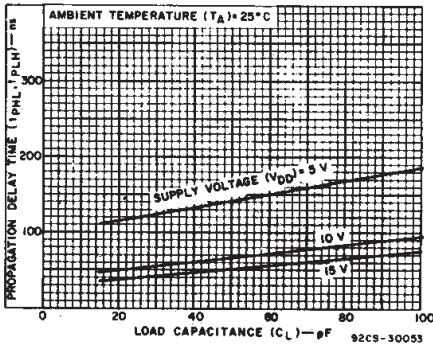

Fig. 7 - Typical propagation delay time as a function of load capacitance.

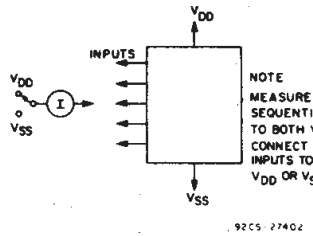

Fig. 12 - Input-current test circuit.

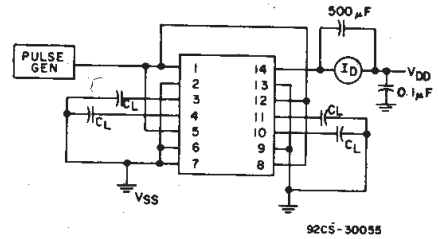

Fig. 13 - Dynamic power dissipation test circuit.

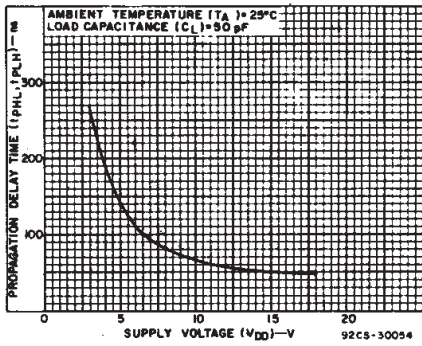

Fig. 8 - Typical propagation delay time as a function of supply voltage.

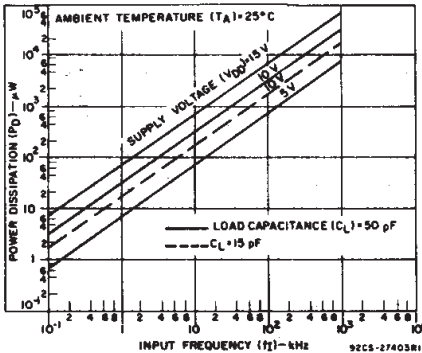
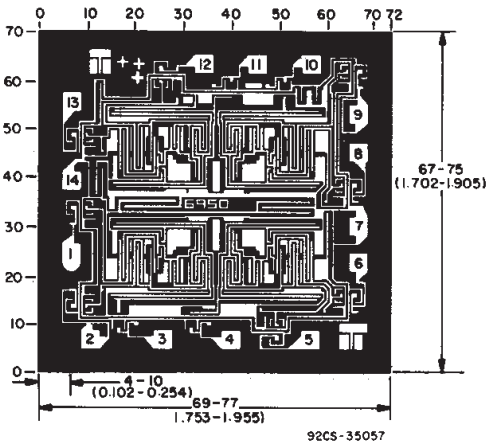

Fig. 9 - Typical dynamic power dissipation as a function of input frequency.



Dimensions and pad layout for CD4030BH.

Dimensions in parentheses are in millimeters and are derived from the basic inch dimensions as indicated. Grid graduations are in mils ( $10^{-3}$  inch).

**PACKAGING INFORMATION**

| Orderable Device | Status<br>(1) | Package Type | Package Drawing | Pins | Package Qty | Eco Plan<br>(2)         | Lead/Ball Finish<br>(6) | MSL Peak Temp<br>(3) | Op Temp (°C) | Device Marking<br>(4/5) | Samples                 |
|------------------|---------------|--------------|-----------------|------|-------------|-------------------------|-------------------------|----------------------|--------------|-------------------------|-------------------------|
| CD4030BE         | ACTIVE        | PDIP         | N               | 14   | 25          | Pb-Free (RoHS)          | CU NIPDAU               | N / A for Pkg Type   | -55 to 125   | CD4030BE                | <a href="#">Samples</a> |
| CD4030BEE4       | ACTIVE        | PDIP         | N               | 14   | 25          | Pb-Free (RoHS)          | CU NIPDAU               | N / A for Pkg Type   | -55 to 125   | CD4030BE                | <a href="#">Samples</a> |
| CD4030BF         | ACTIVE        | CDIP         | J               | 14   | 1           | TBD                     | A42                     | N / A for Pkg Type   | -55 to 125   | CD4030BF                | <a href="#">Samples</a> |
| CD4030BF3A       | ACTIVE        | CDIP         | J               | 14   | 1           | TBD                     | A42                     | N / A for Pkg Type   | -55 to 125   | CD4030BF3A              | <a href="#">Samples</a> |
| CD4030BM         | ACTIVE        | SOIC         | D               | 14   | 50          | Green (RoHS & no Sb/Br) | CU NIPDAU               | Level-1-260C-UNLIM   | -55 to 125   | CD4030BM                | <a href="#">Samples</a> |
| CD4030BM96       | ACTIVE        | SOIC         | D               | 14   | 2500        | Green (RoHS & no Sb/Br) | CU NIPDAU               | Level-1-260C-UNLIM   | -55 to 125   | CD4030BM                | <a href="#">Samples</a> |
| CD4030BM96G4     | ACTIVE        | SOIC         | D               | 14   | 2500        | Green (RoHS & no Sb/Br) | CU NIPDAU               | Level-1-260C-UNLIM   | -55 to 125   | CD4030BM                | <a href="#">Samples</a> |
| CD4030BMG4       | ACTIVE        | SOIC         | D               | 14   | 50          | Green (RoHS & no Sb/Br) | CU NIPDAU               | Level-1-260C-UNLIM   | -55 to 125   | CD4030BM                | <a href="#">Samples</a> |
| CD4030BNSR       | ACTIVE        | SO           | NS              | 14   | 2000        | Green (RoHS & no Sb/Br) | CU NIPDAU               | Level-1-260C-UNLIM   | -55 to 125   | CD4030B                 | <a href="#">Samples</a> |
| CD4030BNSRG4     | ACTIVE        | SO           | NS              | 14   | 2000        | Green (RoHS & no Sb/Br) | CU NIPDAU               | Level-1-260C-UNLIM   | -55 to 125   | CD4030B                 | <a href="#">Samples</a> |
| CD4030BPW        | ACTIVE        | TSSOP        | PW              | 14   | 90          | Green (RoHS & no Sb/Br) | CU NIPDAU               | Level-1-260C-UNLIM   | -55 to 125   | CM030B                  | <a href="#">Samples</a> |
| CD4030BPWG4      | ACTIVE        | TSSOP        | PW              | 14   | 90          | Green (RoHS & no Sb/Br) | CU NIPDAU               | Level-1-260C-UNLIM   | -55 to 125   | CM030B                  | <a href="#">Samples</a> |
| CD4030BPWR       | ACTIVE        | TSSOP        | PW              | 14   | 2000        | Green (RoHS & no Sb/Br) | CU NIPDAU               | Level-1-260C-UNLIM   | -55 to 125   | CM030B                  | <a href="#">Samples</a> |
| JM38510/05353BCA | ACTIVE        | CDIP         | J               | 14   | 1           | TBD                     | A42                     | N / A for Pkg Type   | -55 to 125   | JM38510/<br>05353BCA    | <a href="#">Samples</a> |
| M38510/05353BCA  | ACTIVE        | CDIP         | J               | 14   | 1           | TBD                     | A42                     | N / A for Pkg Type   | -55 to 125   | JM38510/<br>05353BCA    | <a href="#">Samples</a> |

(1) The marketing status values are defined as follows:

**ACTIVE:** Product device recommended for new designs.

**LIFEBUY:** TI has announced that the device will be discontinued, and a lifetime-buy period is in effect.

**NRND:** Not recommended for new designs. Device is in production to support existing customers, but TI does not recommend using this part in a new design.

**PREVIEW:** Device has been announced but is not in production. Samples may or may not be available.

---

**OBSOLETE:** TI has discontinued the production of the device.

(2) **RoHS:** TI defines "RoHS" to mean semiconductor products that are compliant with the current EU RoHS requirements for all 10 RoHS substances, including the requirement that RoHS substance do not exceed 0.1% by weight in homogeneous materials. Where designed to be soldered at high temperatures, "RoHS" products are suitable for use in specified lead-free processes. TI may reference these types of products as "Pb-Free".

**RoHS Exempt:** TI defines "RoHS Exempt" to mean products that contain lead but are compliant with EU RoHS pursuant to a specific EU RoHS exemption.

**Green:** TI defines "Green" to mean the content of Chlorine (Cl) and Bromine (Br) based flame retardants meet JS709B low halogen requirements of  $\leq 1000$ ppm threshold. Antimony trioxide based flame retardants must also meet the  $\leq 1000$ ppm threshold requirement.

(3) **MSL, Peak Temp.** - The Moisture Sensitivity Level rating according to the JEDEC industry standard classifications, and peak solder temperature.

(4) There may be additional marking, which relates to the logo, the lot trace code information, or the environmental category on the device.

(5) Multiple Device Markings will be inside parentheses. Only one Device Marking contained in parentheses and separated by a "~" will appear on a device. If a line is indented then it is a continuation of the previous line and the two combined represent the entire Device Marking for that device.

(6) **Lead/Ball Finish** - Orderable Devices may have multiple material finish options. Finish options are separated by a vertical ruled line. Lead/Ball Finish values may wrap to two lines if the finish value exceeds the maximum column width.

**Important Information and Disclaimer:** The information provided on this page represents TI's knowledge and belief as of the date that it is provided. TI bases its knowledge and belief on information provided by third parties, and makes no representation or warranty as to the accuracy of such information. Efforts are underway to better integrate information from third parties. TI has taken and continues to take reasonable steps to provide representative and accurate information but may not have conducted destructive testing or chemical analysis on incoming materials and chemicals. TI and TI suppliers consider certain information to be proprietary, and thus CAS numbers and other limited information may not be available for release.

In no event shall TI's liability arising out of such information exceed the total purchase price of the TI part(s) at issue in this document sold by TI to Customer on an annual basis.

**OTHER QUALIFIED VERSIONS OF CD4030B, CD4030B-MIL :**

- Catalog: [CD4030B](#)
- Military: [CD4030B-MIL](#)

NOTE: Qualified Version Definitions:

- Catalog - TI's standard catalog product
- Military - QML certified for Military and Defense Applications

**TAPE AND REEL INFORMATION**

**QUADRANT ASSIGNMENTS FOR PIN 1 ORIENTATION IN TAPE**

\*All dimensions are nominal

| Device     | Package Type | Package Drawing | Pins | SPQ  | Reel Diameter (mm) | Reel Width W1 (mm) | A0 (mm) | B0 (mm) | K0 (mm) | P1 (mm) | W (mm) | Pin1 Quadrant |
|------------|--------------|-----------------|------|------|--------------------|--------------------|---------|---------|---------|---------|--------|---------------|
| CD4030BM96 | SOIC         | D               | 14   | 2500 | 330.0              | 16.4               | 6.5     | 9.0     | 2.1     | 8.0     | 16.0   | Q1            |
| CD4030BNSR | SO           | NS              | 14   | 2000 | 330.0              | 16.4               | 8.2     | 10.5    | 2.5     | 12.0    | 16.0   | Q1            |
| CD4030BPWR | TSSOP        | PW              | 14   | 2000 | 330.0              | 12.4               | 6.9     | 5.6     | 1.6     | 8.0     | 12.0   | Q1            |

## TAPE AND REEL BOX DIMENSIONS



\*All dimensions are nominal

| Device     | Package Type | Package Drawing | Pins | SPQ  | Length (mm) | Width (mm) | Height (mm) |
|------------|--------------|-----------------|------|------|-------------|------------|-------------|
| CD4030BM96 | SOIC         | D               | 14   | 2500 | 367.0       | 367.0      | 38.0        |
| CD4030BNSR | SO           | NS              | 14   | 2000 | 367.0       | 367.0      | 38.0        |
| CD4030BPWR | TSSOP        | PW              | 14   | 2000 | 367.0       | 367.0      | 35.0        |

J 14

**GENERIC PACKAGE VIEW**  
**CDIP - 5.08 mm max height**  
CERAMIC DUAL IN LINE PACKAGE



Images above are just a representation of the package family, actual package may vary.  
Refer to the product data sheet for package details.

4040083-5/G



J0014A



# PACKAGE OUTLINE

CDIP - 5.08 mm max height

CERAMIC DUAL IN LINE PACKAGE



4214771/A 05/2017

NOTES:

1. All controlling linear dimensions are in inches. Dimensions in brackets are in millimeters. Any dimension in brackets or parenthesis are for reference only. Dimensioning and tolerancing per ASME Y14.5M.
2. This drawing is subject to change without notice.
3. This package is hermetically sealed with a ceramic lid using glass frit.
4. Index point is provided on cap for terminal identification only and on press ceramic glass frit seal only.
5. Falls within MIL-STD-1835 and GDIP1-T14.

# EXAMPLE BOARD LAYOUT

J0014A

CDIP - 5.08 mm max height

CERAMIC DUAL IN LINE PACKAGE



LAND PATTERN EXAMPLE  
NON-SOLDER MASK DEFINED  
SCALE: 5X



4214771/A 05/2017

N (R-PDIP-T\*\*)

PLASTIC DUAL-IN-LINE PACKAGE

16 PINS SHOWN



- NOTES:
- A. All linear dimensions are in inches (millimeters).
  - B. This drawing is subject to change without notice.
  - Falls within JEDEC MS-001, except 18 and 20 pin minimum body length (Dim A).
  - The 20 pin end lead shoulder width is a vendor option, either half or full width.

D (R-PDSO-G14)

PLASTIC SMALL OUTLINE



- NOTES:
- A. All linear dimensions are in inches (millimeters).
  - B. This drawing is subject to change without notice.
  - $\triangle C$  Body length does not include mold flash, protrusions, or gate burrs. Mold flash, protrusions, or gate burrs shall not exceed 0.006 (0,15) each side.
  - $\triangle D$  Body width does not include interlead flash. Interlead flash shall not exceed 0.017 (0,43) each side.
  - E. Reference JEDEC MS-012 variation AB.

D (R-PDSO-G14)

PLASTIC SMALL OUTLINE



4211283-3/E 08/12

- NOTES:
- All linear dimensions are in millimeters.
  - This drawing is subject to change without notice.
  - Publication IPC-7351 is recommended for alternate designs.
  - Laser cutting apertures with trapezoidal walls and also rounding corners will offer better paste release. Customers should contact their board assembly site for stencil design recommendations. Refer to IPC-7525 for other stencil recommendations.
  - Customers should contact their board fabrication site for solder mask tolerances between and around signal pads.

PW (R-PDSO-G14)

PLASTIC SMALL OUTLINE



- NOTES:
- A. All linear dimensions are in millimeters. Dimensioning and tolerancing per ASME Y14.5M-1994.
  - B. This drawing is subject to change without notice.
  - C. Body length does not include mold flash, protrusions, or gate burrs. Mold flash, protrusions, or gate burrs shall not exceed 0,15 each side.
  - D. Body width does not include interlead flash. Interlead flash shall not exceed 0,25 each side.
  - E. Falls within JEDEC MO-153

PW (R-PDSO-G14)

PLASTIC SMALL OUTLINE



- NOTES:
- All linear dimensions are in millimeters.
  - This drawing is subject to change without notice.
  - Publication IPC-7351 is recommended for alternate designs.
  - Laser cutting apertures with trapezoidal walls and also rounding corners will offer better paste release. Customers should contact their board assembly site for stencil design recommendations. Refer to IPC-7525 for other stencil recommendations.
  - Customers should contact their board fabrication site for solder mask tolerances between and around signal pads.

# MECHANICAL DATA

NS (R-PDSO-G\*\*)

PLASTIC SMALL-OUTLINE PACKAGE

14-PINS SHOWN



- NOTES:
- A. All linear dimensions are in millimeters.
  - B. This drawing is subject to change without notice.
  - C. Body dimensions do not include mold flash or protrusion, not to exceed 0,15.



## IMPORTANT NOTICE

Texas Instruments Incorporated (TI) reserves the right to make corrections, enhancements, improvements and other changes to its semiconductor products and services per JESD46, latest issue, and to discontinue any product or service per JESD48, latest issue. Buyers should obtain the latest relevant information before placing orders and should verify that such information is current and complete.

TI's published terms of sale for semiconductor products (<http://www.ti.com/sc/docs/stdterms.htm>) apply to the sale of packaged integrated circuit products that TI has qualified and released to market. Additional terms may apply to the use or sale of other types of TI products and services.

Reproduction of significant portions of TI information in TI data sheets is permissible only if reproduction is without alteration and is accompanied by all associated warranties, conditions, limitations, and notices. TI is not responsible or liable for such reproduced documentation. Information of third parties may be subject to additional restrictions. Resale of TI products or services with statements different from or beyond the parameters stated by TI for that product or service voids all express and any implied warranties for the associated TI product or service and is an unfair and deceptive business practice. TI is not responsible or liable for any such statements.

Buyers and others who are developing systems that incorporate TI products (collectively, "Designers") understand and agree that Designers remain responsible for using their independent analysis, evaluation and judgment in designing their applications and that Designers have full and exclusive responsibility to assure the safety of Designers' applications and compliance of their applications (and of all TI products used in or for Designers' applications) with all applicable regulations, laws and other applicable requirements. Designer represents that, with respect to their applications, Designer has all the necessary expertise to create and implement safeguards that (1) anticipate dangerous consequences of failures, (2) monitor failures and their consequences, and (3) lessen the likelihood of failures that might cause harm and take appropriate actions. Designer agrees that prior to using or distributing any applications that include TI products, Designer will thoroughly test such applications and the functionality of such TI products as used in such applications.

TI's provision of technical, application or other design advice, quality characterization, reliability data or other services or information, including, but not limited to, reference designs and materials relating to evaluation modules, (collectively, "TI Resources") are intended to assist designers who are developing applications that incorporate TI products; by downloading, accessing or using TI Resources in any way, Designer (individually or, if Designer is acting on behalf of a company, Designer's company) agrees to use any particular TI Resource solely for this purpose and subject to the terms of this Notice.

TI's provision of TI Resources does not expand or otherwise alter TI's applicable published warranties or warranty disclaimers for TI products, and no additional obligations or liabilities arise from TI providing such TI Resources. TI reserves the right to make corrections, enhancements, improvements and other changes to its TI Resources. TI has not conducted any testing other than that specifically described in the published documentation for a particular TI Resource.

Designer is authorized to use, copy and modify any individual TI Resource only in connection with the development of applications that include the TI product(s) identified in such TI Resource. NO OTHER LICENSE, EXPRESS OR IMPLIED, BY ESTOPPEL OR OTHERWISE TO ANY OTHER TI INTELLECTUAL PROPERTY RIGHT, AND NO LICENSE TO ANY TECHNOLOGY OR INTELLECTUAL PROPERTY RIGHT OF TI OR ANY THIRD PARTY IS GRANTED HEREIN, including but not limited to any patent right, copyright, mask work right, or other intellectual property right relating to any combination, machine, or process in which TI products or services are used. Information regarding or referencing third-party products or services does not constitute a license to use such products or services, or a warranty or endorsement thereof. Use of TI Resources may require a license from a third party under the patents or other intellectual property of the third party, or a license from TI under the patents or other intellectual property of TI.

TI RESOURCES ARE PROVIDED "AS IS" AND WITH ALL FAULTS. TI DISCLAIMS ALL OTHER WARRANTIES OR REPRESENTATIONS, EXPRESS OR IMPLIED, REGARDING RESOURCES OR USE THEREOF, INCLUDING BUT NOT LIMITED TO ACCURACY OR COMPLETENESS, TITLE, ANY EPIDEMIC FAILURE WARRANTY AND ANY IMPLIED WARRANTIES OF MERCHANTABILITY, FITNESS FOR A PARTICULAR PURPOSE, AND NON-INFRINGEMENT OF ANY THIRD PARTY INTELLECTUAL PROPERTY RIGHTS. TI SHALL NOT BE LIABLE FOR AND SHALL NOT DEFEND OR INDEMNIFY DESIGNER AGAINST ANY CLAIM, INCLUDING BUT NOT LIMITED TO ANY INFRINGEMENT CLAIM THAT RELATES TO OR IS BASED ON ANY COMBINATION OF PRODUCTS EVEN IF DESCRIBED IN TI RESOURCES OR OTHERWISE. IN NO EVENT SHALL TI BE LIABLE FOR ANY ACTUAL, DIRECT, SPECIAL, COLLATERAL, INDIRECT, PUNITIVE, INCIDENTAL, CONSEQUENTIAL OR EXEMPLARY DAMAGES IN CONNECTION WITH OR ARISING OUT OF TI RESOURCES OR USE THEREOF, AND REGARDLESS OF WHETHER TI HAS BEEN ADVISED OF THE POSSIBILITY OF SUCH DAMAGES.

Unless TI has explicitly designated an individual product as meeting the requirements of a particular industry standard (e.g., ISO/TS 16949 and ISO 26262), TI is not responsible for any failure to meet such industry standard requirements.

Where TI specifically promotes products as facilitating functional safety or as compliant with industry functional safety standards, such products are intended to help enable customers to design and create their own applications that meet applicable functional safety standards and requirements. Using products in an application does not by itself establish any safety features in the application. Designers must ensure compliance with safety-related requirements and standards applicable to their applications. Designer may not use any TI products in life-critical medical equipment unless authorized officers of the parties have executed a special contract specifically governing such use. Life-critical medical equipment is medical equipment where failure of such equipment would cause serious bodily injury or death (e.g., life support, pacemakers, defibrillators, heart pumps, neurostimulators, and implantables). Such equipment includes, without limitation, all medical devices identified by the U.S. Food and Drug Administration as Class III devices and equivalent classifications outside the U.S.

TI may expressly designate certain products as completing a particular qualification (e.g., Q100, Military Grade, or Enhanced Product). Designers agree that it has the necessary expertise to select the product with the appropriate qualification designation for their applications and that proper product selection is at Designers' own risk. Designers are solely responsible for compliance with all legal and regulatory requirements in connection with such selection.

Designer will fully indemnify TI and its representatives against any damages, costs, losses, and/or liabilities arising out of Designer's non-compliance with the terms and provisions of this Notice.