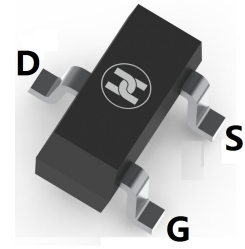
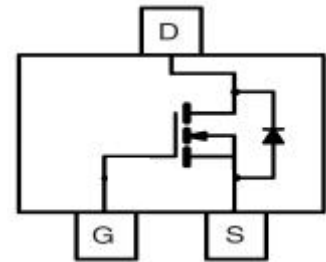

MOSFET (N-CHANNEL)
FEATURES

- Low On-Resistance: $R_{DS(ON)}$
- Low Gate Threshold Voltage
- Low Input Capacitance
- Fast Switching Speed
- Low Input/Output Leakage

SOT-23

MECHANICAL DATA

- Case: SOT-23
- Case Material: Molded Plastic. UL flammability
- Classification Rating: 94V-0
- Moisture Sensitivity: Level 1 per J-STD-020
- Weight: 0.008 grams (approximate)

MAXIMUM RATINGS ($T_A = 25^\circ\text{C}$ unless otherwise noted)

Parameter	Symbol	Value	Unit
Drain-source voltage	V_{DS}	60	V
Drain-gate voltage ($R_{GS} = 20\text{ k}\Omega$)	V_{DGR}	60	V
Gate-source voltage	V_{GS}	$\pm 20\text{V}$	V
Continuous drain current	I_D	115	mA
Pulsed drain current (Note 1)	I_{DM}	800	mA
Power dissipation	P_D	0.35	W
Thermal resistance from Junction to ambient	$R_{\theta JA}$	357	$^\circ\text{C/W}$
Junction And Storage temperature Range	T_J, T_{STG}	-65 ~ +150	$^\circ\text{C}$

ELECTRICAL CHARACTERISTICS ($T_A = 25^\circ\text{C}$ unless otherwise specified)

Parameter	Symb	Min	Typ	Max	Unit	Conditions
Static Characteristics						
Drain-Source breakdown voltage	$V_{(BR)DSS}$	60			V	$V_{GS}=0\text{V}, I_D=250\mu\text{A}$
Gate-threshold voltage (note 1)	$V_{GS(th)}$	1	2.1	2.5	V	$V_{DS}=V_{GS}, I_D=250\mu\text{A}$
Zero gate voltage drain current	I_{DSS}			80	nA	$V_{DS}=60\text{V}, V_{GS}=0\text{V}$
Gate-body leakage current	I_{GSS}			± 80	nA	$V_{DS}=0\text{V}, V_{GS}=\pm 20\text{V}$
On-state Drain Current	$I_{D(ON)}$	500			mA	$V_{GS}=10\text{V}, V_{DS}=7\text{V}$
Drain-source on-resistance (note 1)	$R_{DS(ON)}$			5	Ω	$V_{GS}=10\text{V}, I_D=500\text{mA}$
				7	Ω	$V_{GS}=5\text{V}, I_D=50\text{mA}$
Forward Trans conductance	g_{fs}	80			ms	$V_{DS}=10\text{V}, I_D=200\text{mA}$
Drain-source on-voltage	$V_{DS(on)}$			3.75	V	$V_{GS}=10\text{V}, I_D=500\text{mA}$
				0.37	V	$V_{GS}=5\text{V}, I_D=50\text{mA}$
Diode forward voltage (note 1)	V_{SD}	0.55		1.2	V	$I_S=115\text{mA}, V_{GS}=0\text{V}$
Dynamic Characteristics						
Input capacitance	C_{iss}			50	pF	$V_{DS}=25\text{V}, V_{GS}=0\text{V}, f=1\text{MHz}$
Output capacitance	C_{oss}			25	pF	
Reverse transfer capacitance	C_{rss}			5	pF	
Switching Characteristics						
Turn-on delay time	$t_{d(on)}$			20	nS	$V_{DD}=25\text{V}, V_{GEN}=10\text{V}, R_G=25\Omega, I_D=500\text{mA}, R_L=50\Omega$
Turn-off delay time	$t_{d(off)}$			40	nS	

Note:1. Pulse test ; Pulse width $\leq 300\mu\text{s}$, Duty cycle $\leq 2\%$.

MOSFET (N-CHANNEL)

Typical Characteristics

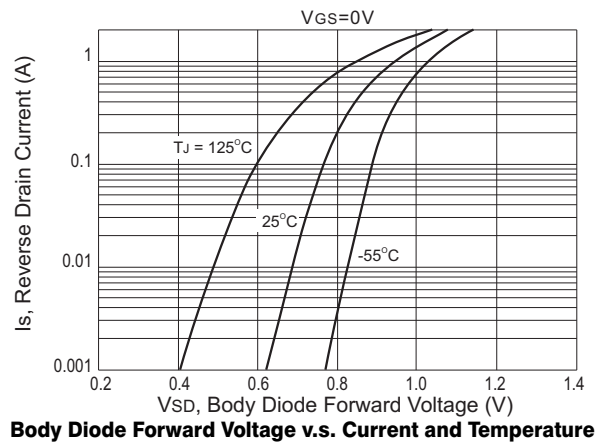
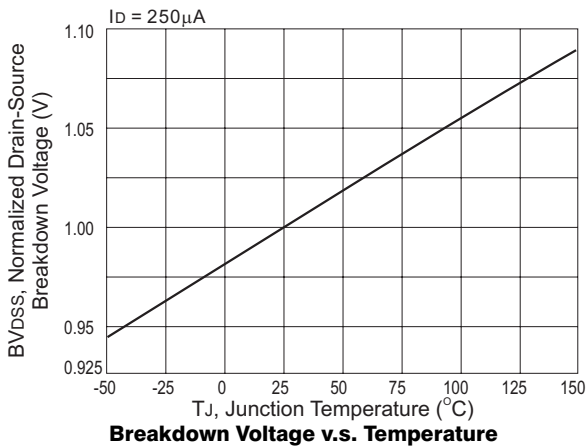
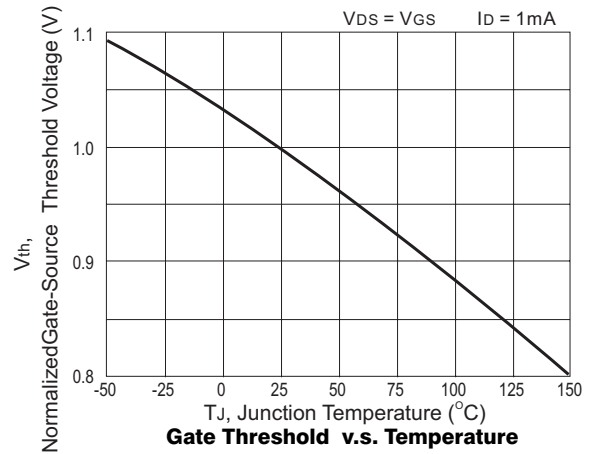
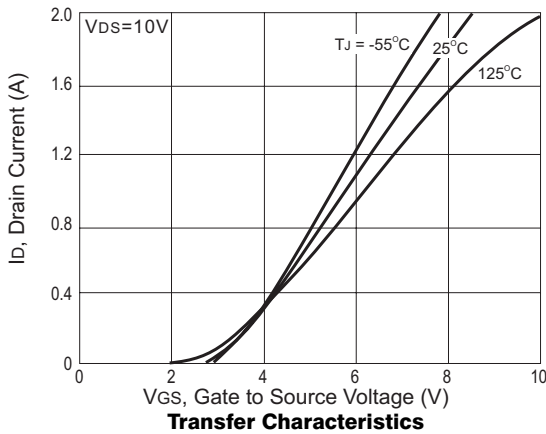
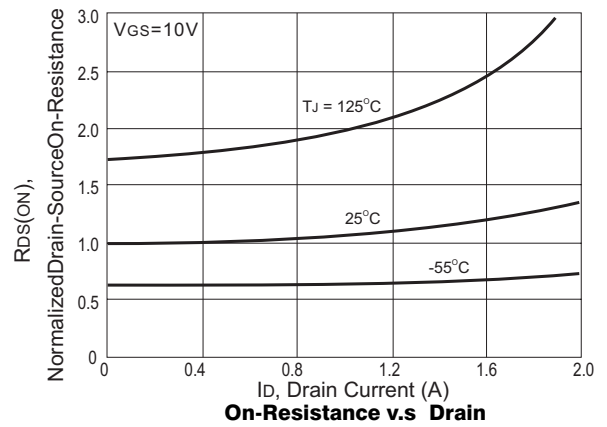
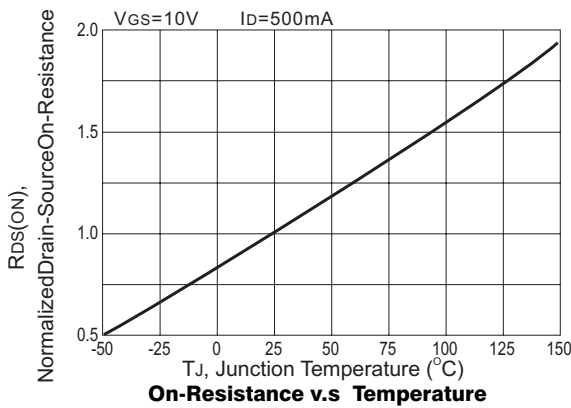
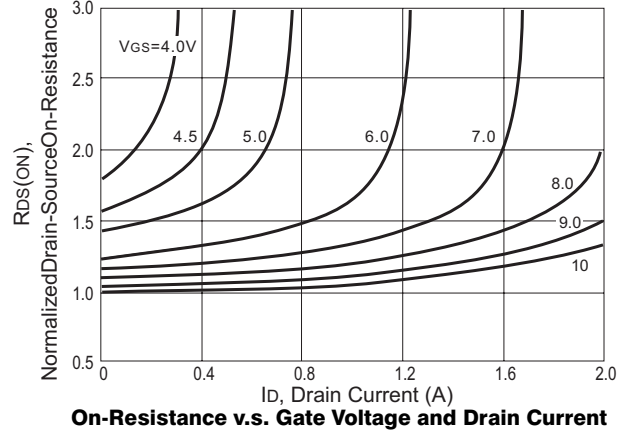
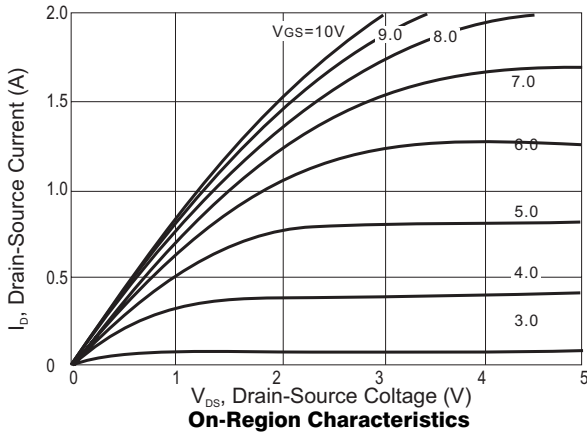

MOSFET (N-CHANNEL)

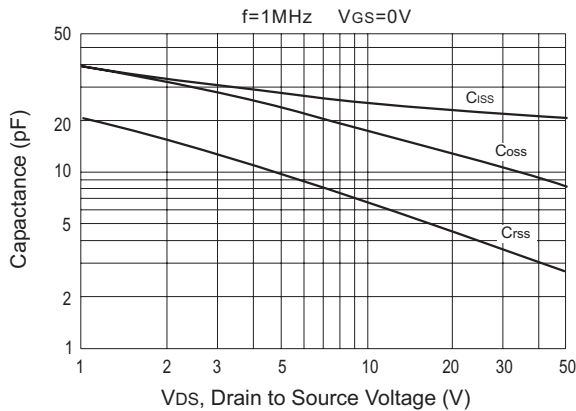

Capacitance Characteristics

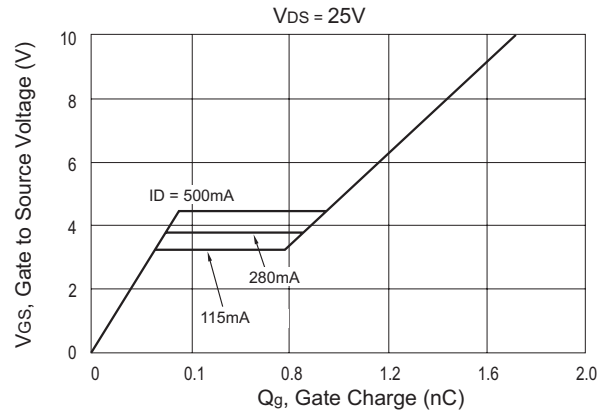

Gate Charge Characteristics

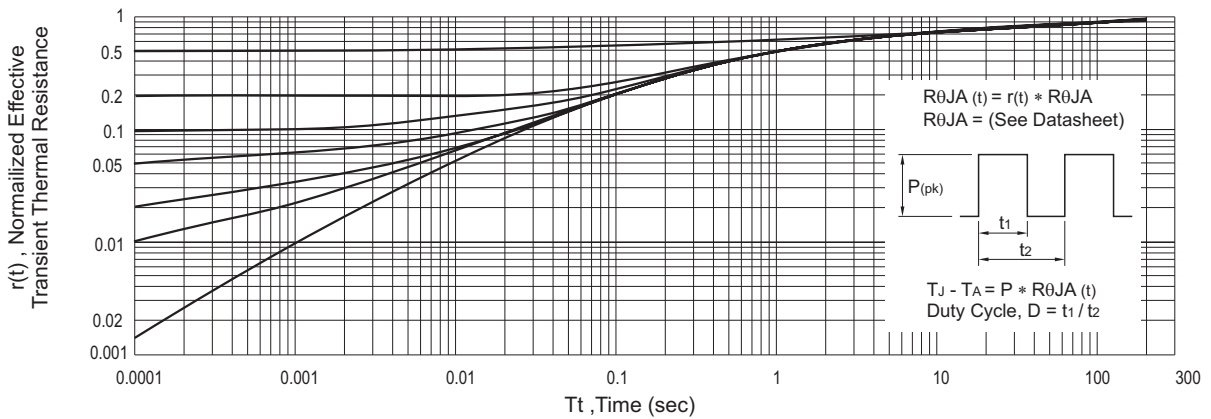

Transient Thermal Response Curve

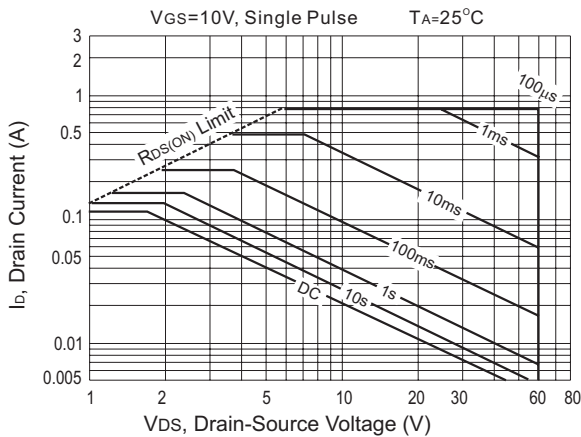

Maximum Safe Operating Area

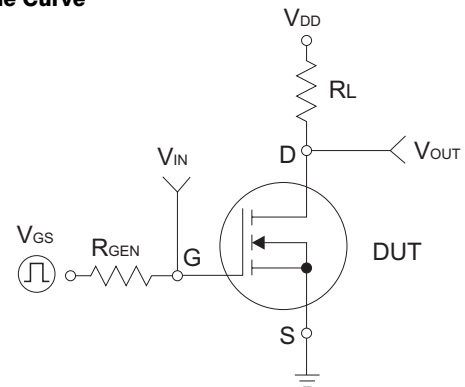

Switching Test Circuit

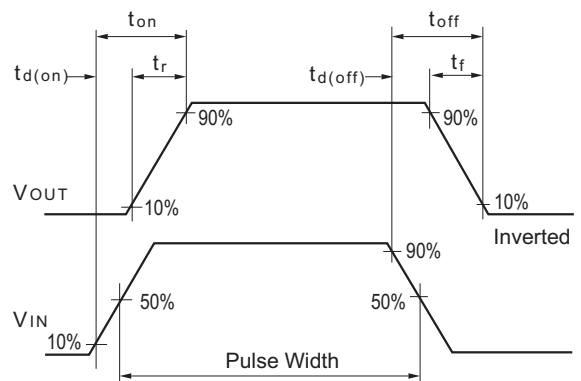

Switching Waveforms

MOSFET (N-CHANNEL)

SOT-23 Package Outline Dimensions

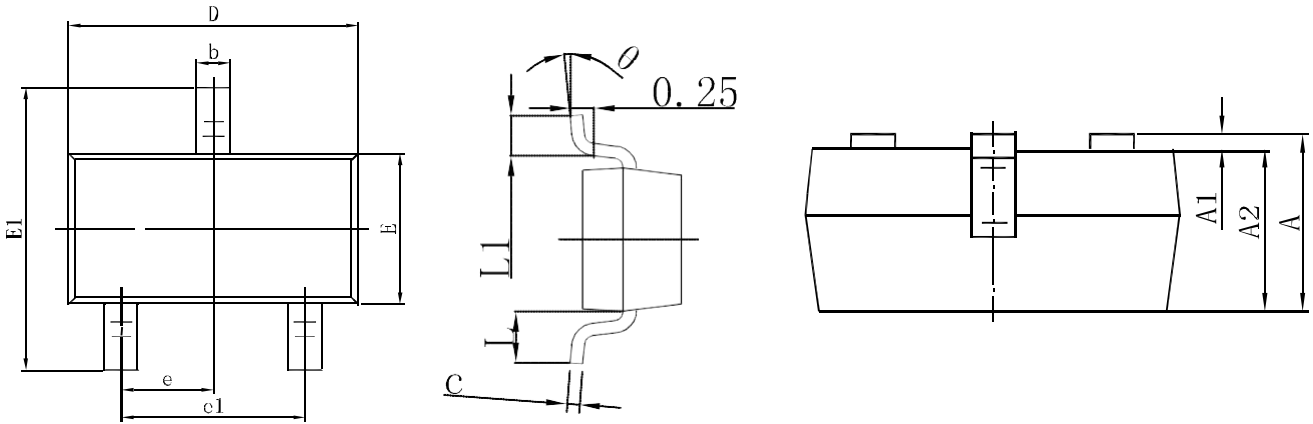

Symbol	Dimensions In Millimeters		Dimensions In Inches	
	Min.	Max.	Min.	Max.
A	0.900	1.150	0.035	0.045
A1	0.000	0.100	0.000	0.004
A2	0.900	1.050	0.035	0.041
b	0.300	0.500	0.012	0.020
c	0.080	0.150	0.003	0.006
D	2.800	3.000	0.110	0.118
E	1.200	1.400	0.047	0.055
E1	2.250	2.550	0.089	0.100
e	0.950 TYP		0.037 TYP	
e1	1.800	2.000	0.071	0.079
L	0.550 REF		0.022 REF	
L1	0.300	0.500	0.012	0.020
θ	0°	8°	0°	8°

SOT-23 Suggested Pad Layout

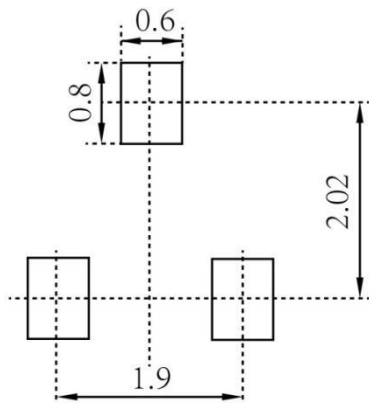

Note:

1. Controlling dimension: in millimeters
2. General tolerance: ±0.05mm
3. The pad layout is for reference purposes only

MOSFET (N-CHANNEL)

SOT-23 Tape and Reel

SOT-23 Embossed Carrier Tape

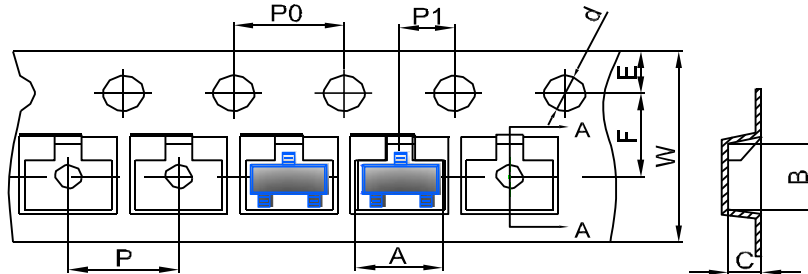

DIMENSIONS ARE IN MILLIMETER										
TYPE	A	B	C	d	E	F	P0	P	P1	W
SOT-23	3.15	2.77	1.22	Ø1.50	1.75	3.50	4.00	4.00	2.00	8.00
TOLERANCE	±0.1	±0.1	±0.1	±0.1	±0.1	±0.1	±0.1	±0.1	±0.1	±0.1

SOT-23 Tape Leader and Trailer

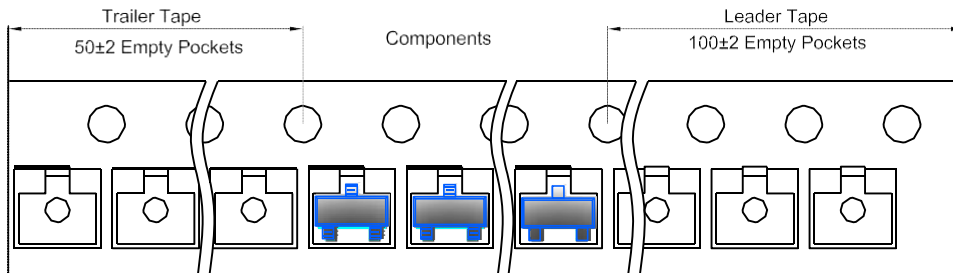

SOT-23 Reel

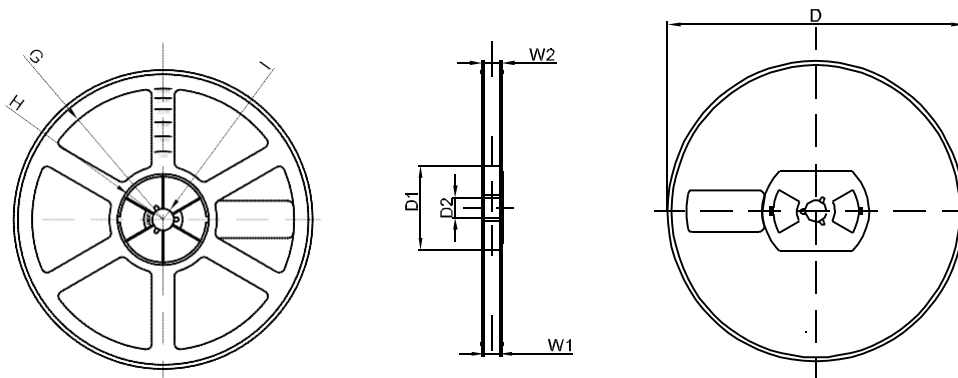

DIMENSIONS ARE IN MILLIMETER								
REEL OPTION	D	D1	D2	G	H	I	W1	W2
7" DIA	Ø178	54.40	13.00	R78	R25.60	R6.50	9.50	12.30
TOLERANCE	±2	±1	±1	±1	±1	±1	±1	±1