



SPS-443 Series

Receiver Pre-amp Module for Infrared Remote Control

Features

- This is an unified module consisting of a PIN photodiode and receiver pre-amp IC.
It is a compact type, not necessary to mount outer part, and provides low voltage and low power consumption.
- It also puts a measure to inverter fluorescent lamp with a high frequency trap circuit for band-pass filter.

Absolute Maximum Ratings at Ta=25°C (as per JIS C 7032)

Parameter	Symbol	Rating	Unit
Line Voltage	VCC	0 to +6.3	V
Power Dissipation	PD	100	mW
Operating Temperature	Topr	-10 to +60	°C
Storage Temperature	Tstg	-20 to +70	°C
Soldering Temperature	Tsol	+260 *1	°C

Recommended Operating Condition at Ta=25°C

Parameter	Symbol	Opr. Condition	Unit
Line Voltage	VCC	+4.7 to +5.3	V

We recommend the signal format with leader code (for example ; NEC format or Home Electrical Appliances Society format in Japan) for the remote control transmitter.

Electrical / Optical Characteristics at Ta=25°C, VCC=5.0V D.C.

Parameter	Symbol	Condition	Min.	Typ.	Max.	Unit
Consumption Current	ICC	Non-signal input	-	1.4	2.2	mA
Controlling Distance	L	*2 On axis	7.5	10.0	-	m
		*2 form device Cone with its limit inclined at 30 deg to axis	5.0	-	-	m
		Cone with its limit inclined at 40 deg to axis	3.0	-	-	m
Low-level Output Voltage	VL	*2 At the point of 30cm on axis	-	-	0.5	V
High-level Output Voltage	VH	*2 At the point of 30cm on axis	4.5	-	-	V
Low-level Pulse Width	TWL	*2 Specified by TWL time interval of output at the point of 30cm and 7.5m on axis	300	610	900	μs
High-level Pulse Width	TWH	*2 Specified by TWH time interval of output at the point of 30cm and 7.5m on axis	300	590	900	μs
Carrier Wave Frequency	f _o	-	-	*3	-	kHz

*1 Soldering time : with in 3sec and clearance of 1mm from lead stopper.

*2 As shown in Fig.1, burst wave shall be transmitted by our transmitter in item 7. Detector face illuminance : E_e < 10 lx

*3 Carrier wave frequency (fo) differs every a type. Refer to the following list.

SANYO Electric Co., Ltd. Semiconductor Company

TOKYO OFFICE Tokyo Bldg., 1-10, 1 Chome, Ueno, Taito-ku, TOKYO, 110-8534 JAPAN

D2099 GI, (MI) No.6044 1/5

SPS-443 Series

Type No.	Carrier wave frequency (fo)
SPS-443-E	40 kHz
SPS-443-1-E	38 kHz
SPS-443-2-E	36.7 kHz
SPS-443-3-E	33.3 kHz
SPS-443-4-E	36 kHz
SPS-443-6-E	56.8 kHz

Precautions of Use ▲Precautions

- (1) Care must be taken to avoid bending leads.
- (2) Do not apply any force or mechanical stress onto the leads or plastic part during soldering.
- (3) Confirm reliability in terms of devices, because it sometimes acts be wrong by the ingredient of the ripple noise of the power supply lines.

Please design the ripple voltage of the power supply line below 1mVp-p.

Please attach the RC filter (R=100Ω, C=22μF) for the power supply lines.

Pulse Waveform

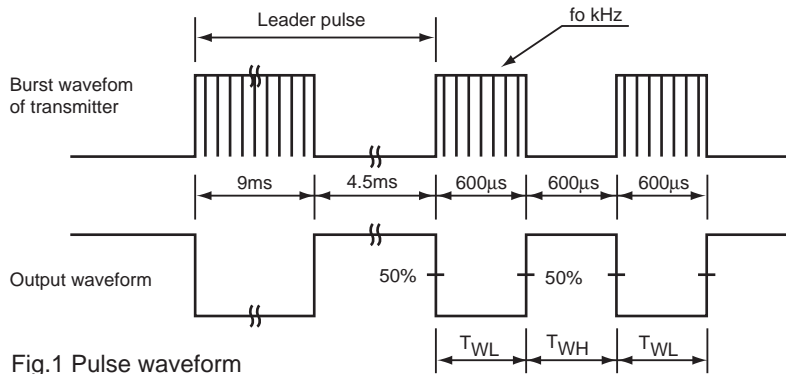

Fig.1 Pulse waveform

Transmitter

The Transmitter shall be defined by adjusting the output of transmitter to make $V_o=400mV_{p-p}$ according to the burst wave shown in Fig. 1 and measurement condition shown in Fig.2. In addition infrared LED used in the transmitter is set to $\lambda_{peak}=945nm$, $\Delta\lambda=45nm$, and photodiode used in the receiver is set to $32nA / I_x$ ($V_R=5.0V$).

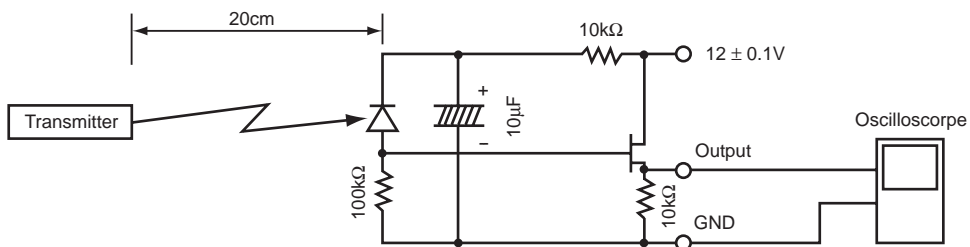

Fig.2 The output adjustment of transmitter

Measurement Condition

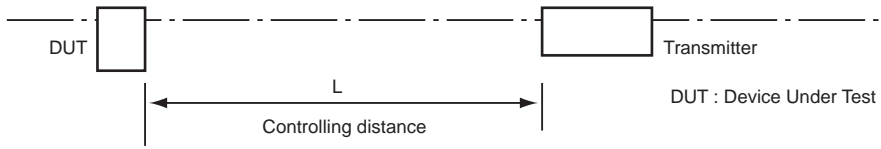

Fig.3 Measurement Condition

Block Diagram

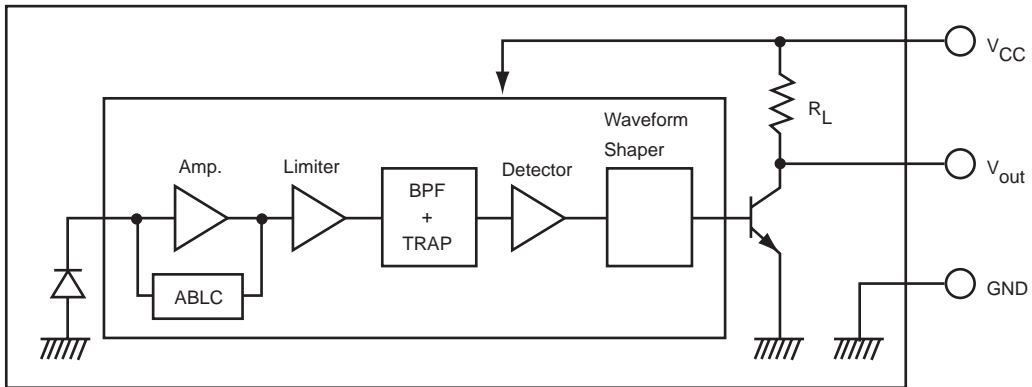
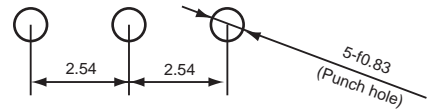
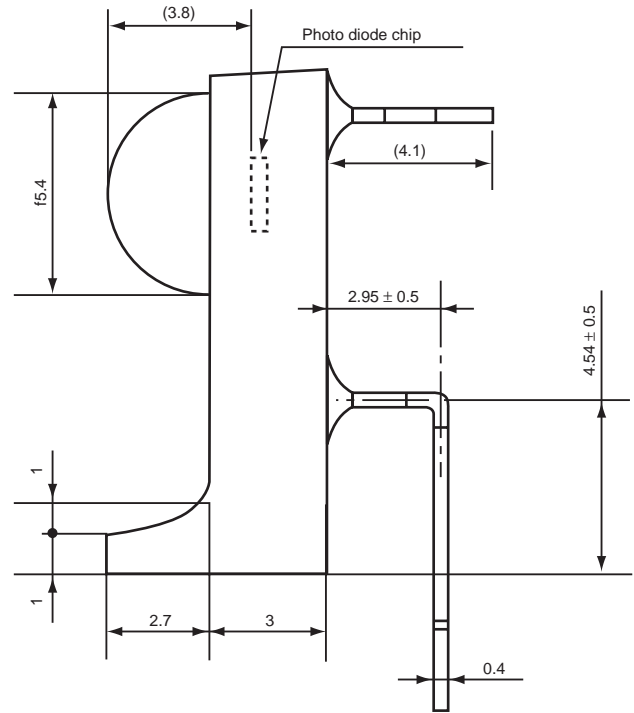
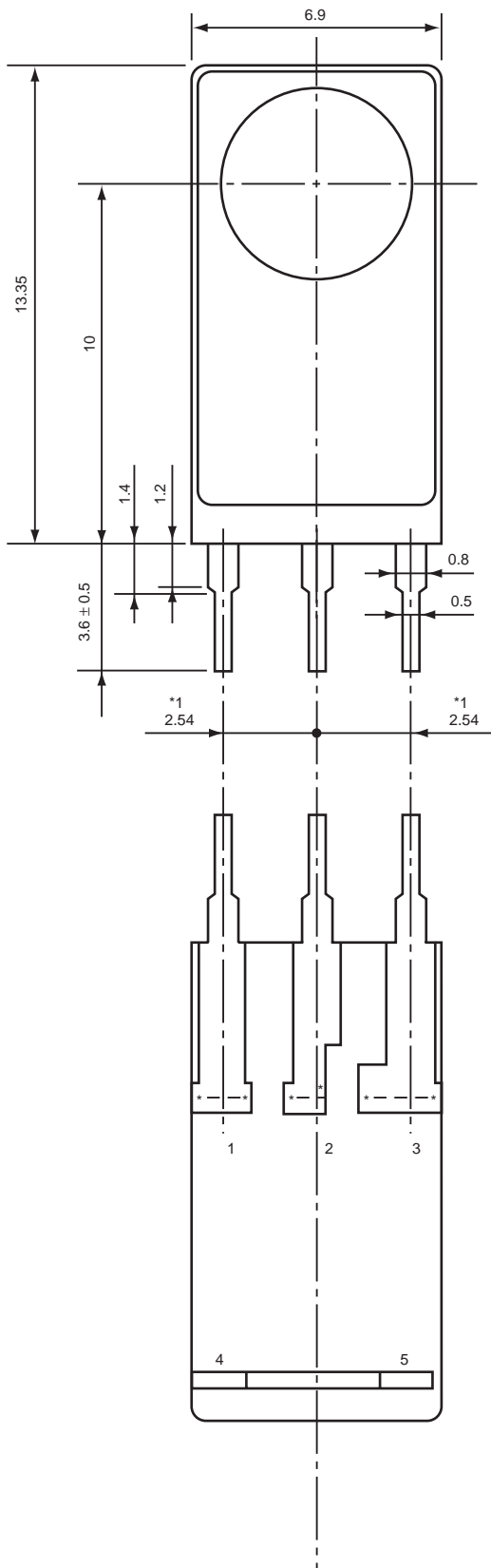

Fig.4 Block Diagram

- Note 1. V_{out} : Active "Low" output
- 2. $R_L = 15k\Omega$ to $51k\Omega$
- 3. The power supply filter is not being attached.

SPS-443 Series

SPS-443 Series Package Dimensions and Pinconnection



< Recommended mounting drawing from soldering side >

- 1 GND
- 2 V_{out}
- 3 VCC
- (4 GND)
- (5 GND)

Tolerance : ± 0.3
Unit : mm

- Note
- 1) *1 indicates root dimensions of leads.
 - 2) Pin4, Pin5 has been connected Pin1 (GND) in a product.
 - 3) The width and position of the leads of "*" marke may be changed.

CAUTION

1. No products described or contained herein are intended for use in surgical implants, life-support systems, aerospace equipment, nuclear power control systems, vehicles, disaster / crime-prevention equipment or the like, and the failure of which may directly or indirectly cause injury, death or property loss.
2. Anyone purchasing any products described or contained herein for an above-mentioned use shall:
 - 1) Accept full responsibility and indemnify and defend SANYO ELECTRIC CO.,LTD., it's affiliates, subsidiaries and distributors or any of their officers and employees, jointly and severally, against any and all claims and litigation and all damages, costs and expenses associated with such use.
 - 2) Not impose any responsibility for any fault or negligence which may be cited in any such claim or litigation on SANYO ELECTRIC CO., LTD., it's affiliates, subsidiaries and distributors or any of their officers and employees jointly or severally.
3. Information (including circuit diagrams and circuit parameters) disclosed herein is for example only; it is not guaranteed for mass production, SANYO believes the information disclosed herein is accurate and reliable, but no guarantees are made or implied regarding it's use or any infringements of intellectual property rights or other rights of third parties.

Precautionary instructions in handling gallium arsenic products

Special precautions must be taken in handling this product because it contains, gallium arsenic, which is designated as a toxic substance by law. Be sure to adhere strictly to all applicable laws and regulations enacted for this substance, particularly when it comes to disposal.

Manufactured by ; **Tottori SANYO Electric Co., Ltd.**
LED Division
5-318, Tachikawa-cho, Tottori City, 680-8634 Japan
TEL: +81-857-21-2137 FAX: +81-857-21-2161