

# International IR Rectifier

## 25CTQ... 25CTQ...S 25CTQ.. -1

SCHOTTKY RECTIFIER

30 Amp

$$I_{F(AV)} = 30\text{Amp}$$

$$V_R = 35/45\text{V}$$

### Major Ratings and Characteristics



Characteristics	Values	Units
$I_{F(AV)}$ Rectangular waveform	30	A
$V_{RRM}$ range	35/45	V
$I_{FSM}$ @tp=5µs sine	990	A
$V_F$ @15Apk, $T_J=125^\circ\text{C}$ (per leg)	0.50	V
$T_J$ range	-55 to 150	$^\circ\text{C}$

### Description/ Features

The 25CTQ center tap Schottky rectifier series has been optimized for very low forward voltage drop, with moderate leakage. The proprietary barrier technology allows for reliable operation up to 150° C junction temperature. Typical applications are in switching power supplies, converters, free-wheeling diodes, and reverse battery protection.

- 150° C  $T_J$  operation
- Center tap TO-220 package
- High purity, high temperature epoxy encapsulation for enhanced mechanical strength and moisture resistance
- Very low forward voltage drop
- High frequency operation
- Guard ring for enhanced ruggedness and long term reliability

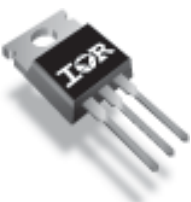
### Case Styles

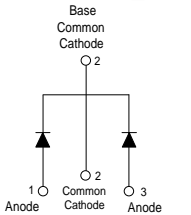
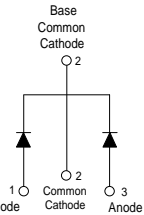
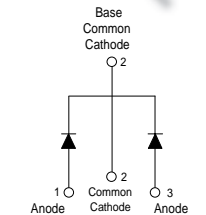
25CTQ...	25CTQ... S	25CTQ... -1
		
<p>Base Common Cathode</p> <p>2</p>  <p>1 Anode 2 Common Cathode 3 Anode</p> <p>TO-220</p>	<p>Base Common Cathode</p> <p>2</p>  <p>1 Anode 2 Common Cathode 3 Anode</p> <p>D²PAK</p>	<p>Base Common Cathode</p> <p>2</p>  <p>1 Anode 2 Common Cathode 3 Anode</p> <p>TO-262</p>

### Voltage Ratings

Part number	25CTQ035	25CTQ040	25CTQ045
$V_R$ Max. DC Reverse Voltage (V)	35	40	45
$V_{RWM}$ Max. Working Peak Reverse Voltage (V)			

### Absolute Maximum Ratings

Parameters	25CTQ	Units	Conditions
$I_{F(AV)}$ Max. Average Forward Current * See Fig. 5	30	A	50% duty cycle @ $T_C = 102^\circ\text{C}$ , rectangular wave form
$I_{FSM}$ Max. Peak One Cycle Non-Repetitive Surge Current (Per Leg) * See Fig. 7	990	A	5 $\mu\text{s}$ Sine or 3 $\mu\text{s}$ Rect. pulse 10ms Sine or 6ms Rect. pulse
	250		
$E_{AS}$ Non-Repetitive Avalanche Energy (Per Leg)	20	mJ	$T_J = 25^\circ\text{C}$ , $I_{AS} = 3\text{Amps}$ , $L = 4.40\text{mH}$
$I_{AR}$ Repetitive Avalanche Current (Per Leg)	3	A	Current decaying linearly to zero in 1 $\mu\text{sec}$ Frequency limited by $T_J$ max. $V_A = 1.5 \times V_R$ typical

### Electrical Specifications

Parameters	25CTQ	Units	Conditions
$V_{FM}$ Max. Forward Voltage Drop (Per Leg) * See Fig. 1 (1)	0.56	V	@ 15A
	0.71	V	@ 30A
	0.50	V	@ 15A
	0.64	V	@ 30A
$I_{RM}$ Max. Reverse Leakage Current (Per Leg) * See Fig. 2 (1)	1.75	mA	$T_J = 25^\circ\text{C}$
	70	mA	$T_J = 125^\circ\text{C}$
$C_T$ Max. Junction Capacitance (Per Leg)	900	pF	$V_R = 5V_{DC}$ (test signal range 100Khz to 1Mhz) $25^\circ\text{C}$
$L_S$ Typical Series Inductance (Per Leg)	8.0	nH	Measured lead to lead 5mm from package body
$dv/dt$ Max. Voltage Rate of Change (Rated $V_R$ )	10000	V/ $\mu\text{s}$	

(1) Pulse Width < 300 $\mu\text{s}$ , Duty Cycle <2%

### Thermal-Mechanical Specifications

Parameters	25CTQ	Units	Conditions
$T_J$ Max. Junction Temperature Range	-55 to 150	$^\circ\text{C}$	
$T_{stg}$ Max. Storage Temperature Range	-55 to 150	$^\circ\text{C}$	
$R_{thJC}$ Max. Thermal Resistance Junction to Case (Per Leg)	3.25	$^\circ\text{C/W}$	DC operation * See Fig. 4
$R_{thJC}$ Max. Thermal Resistance Junction to Case (Per Package)	1.63	$^\circ\text{C/W}$	DC operation
$R_{thCS}$ Typical Thermal Resistance, Case to Heatsink	0.50	$^\circ\text{C/W}$	Mounting surface, smooth and greased
wt Approximate Weight	2.0 (0.07)	g (oz.)	
T Mounting Torque	Min.	6 (5)	Kg-cm (lbf-in)
	Max.	12 (10)	

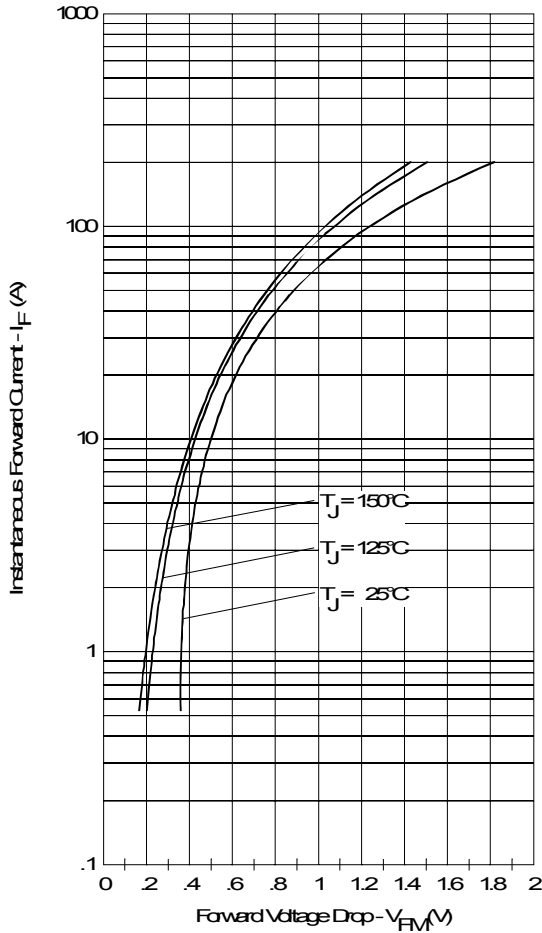

Fig. 1 - Max. Forward Voltage Drop Characteristics (Per Leg)

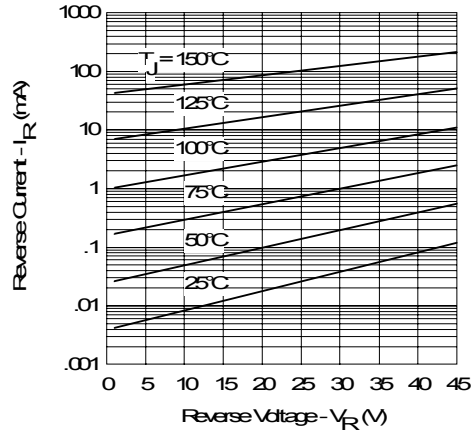

Fig. 2 - Typical Values Of Reverse Current Vs. Reverse Voltage (Per Leg)

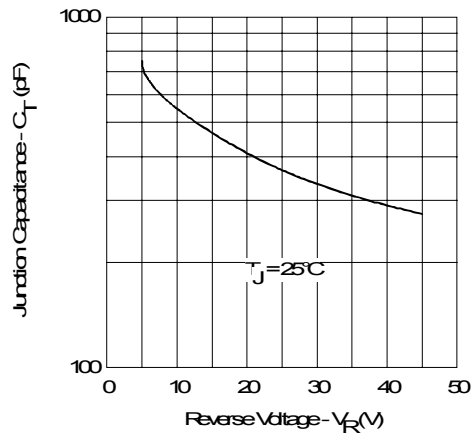

Fig. 3 - Typical Junction Capacitance Vs. Reverse Voltage (Per Leg)

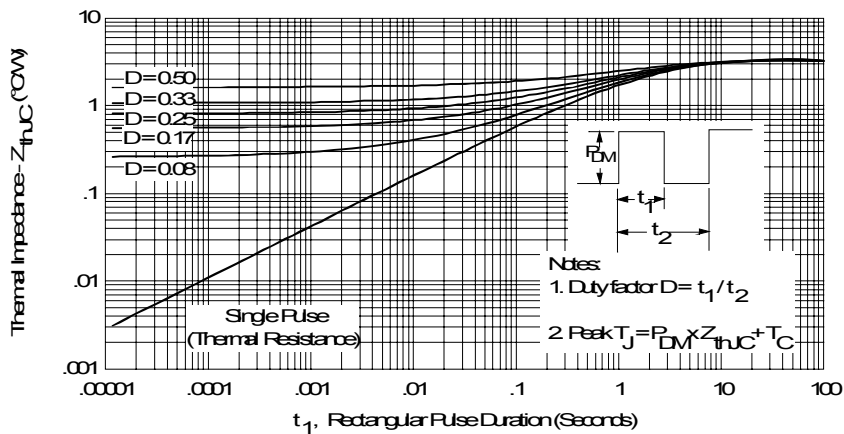

Fig. 4 - Max. Thermal Impedance  $Z_{thJC}$  Characteristics (Per Leg)

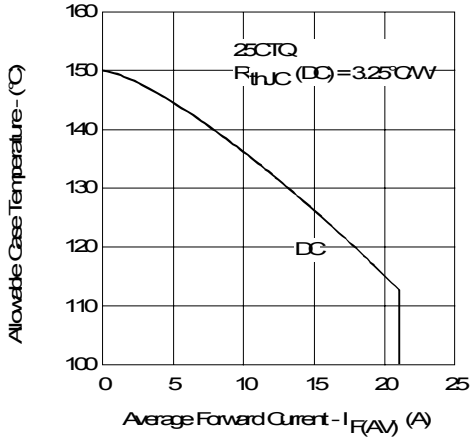

Fig. 5 - Max. Allowable Case Temperature Vs. Average Forward Current (Per Leg)

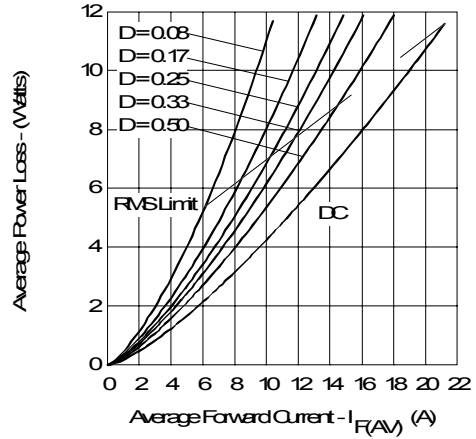

Fig. 6 - Forward Power Loss Characteristics (Per Leg)

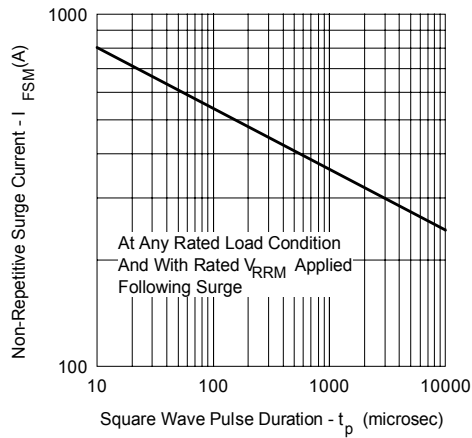

Fig. 7 - Max. Non-Repetitive Surge Current (Per Leg)

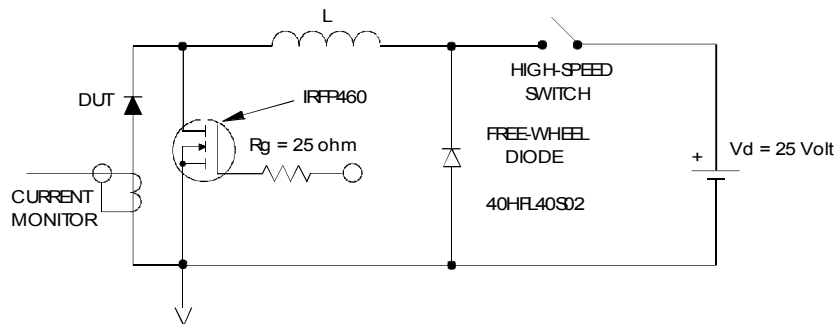
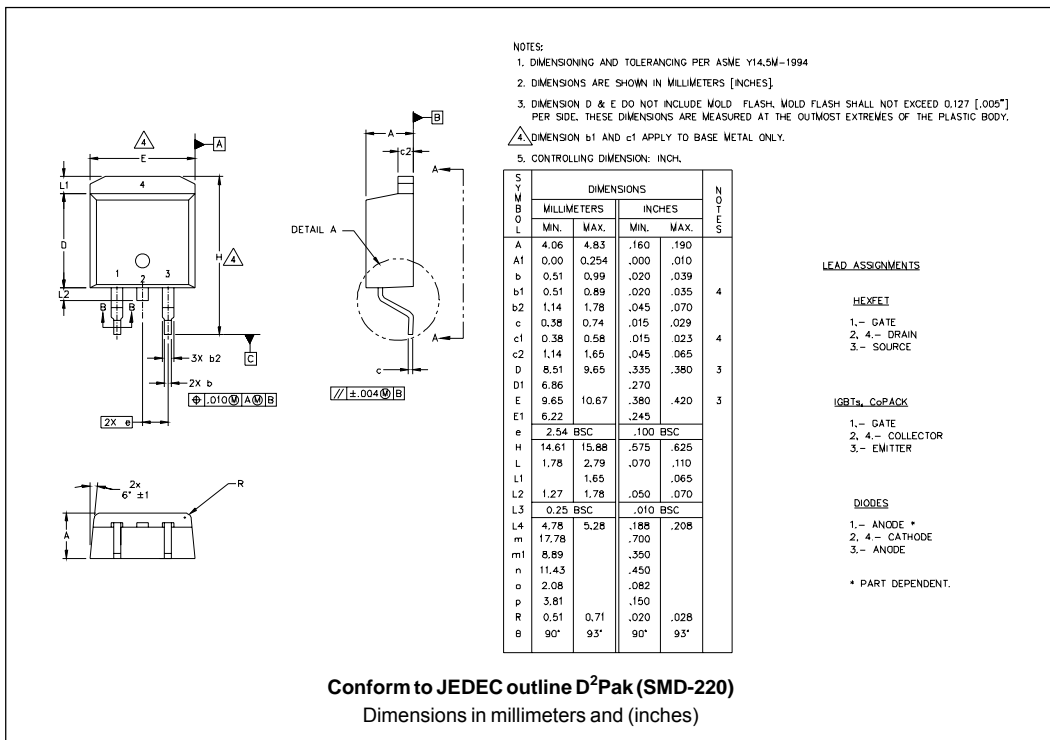
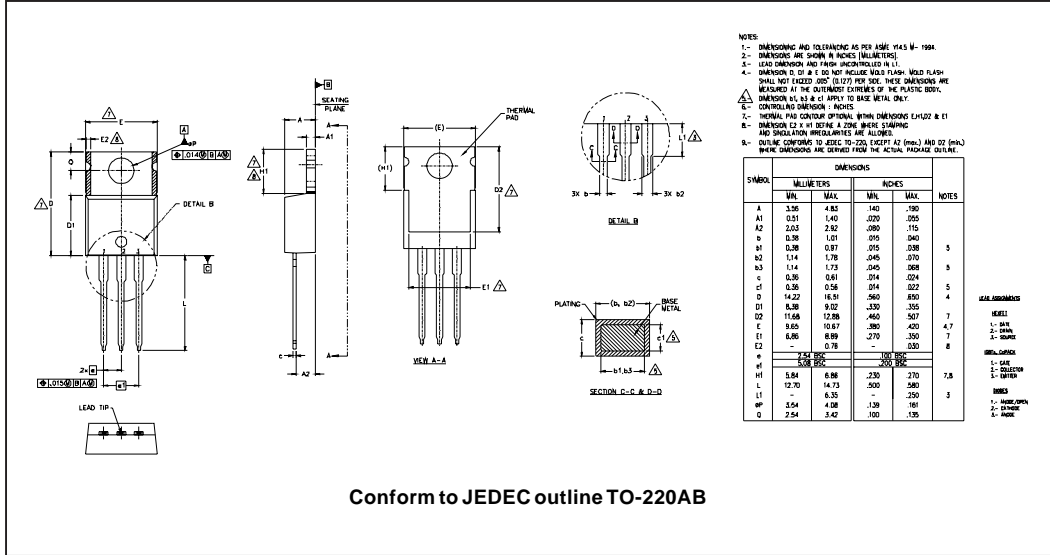
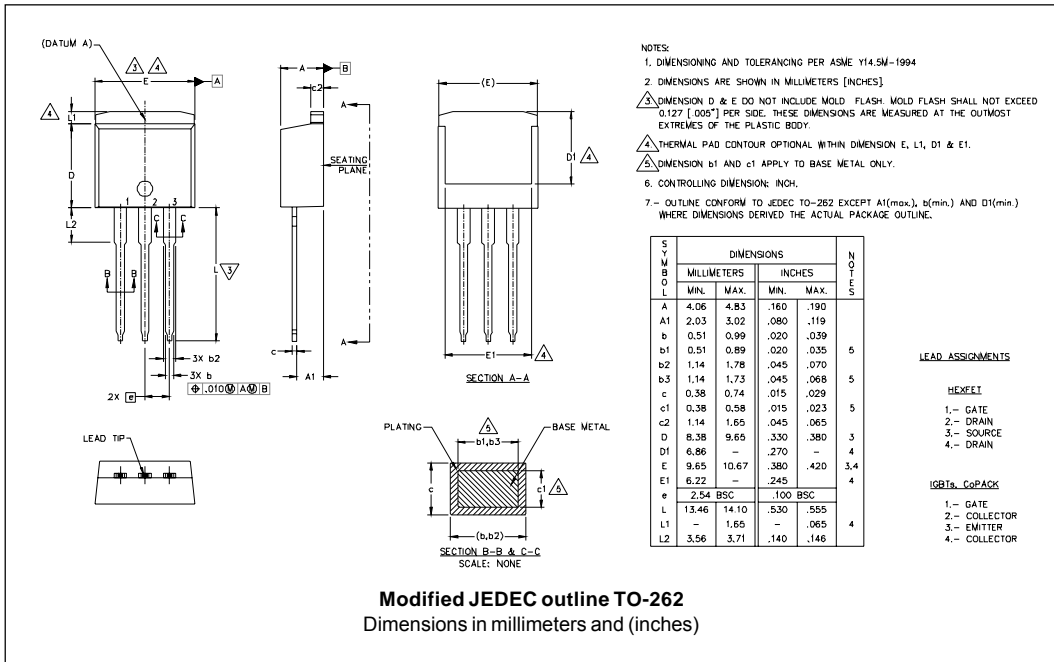

Fig. 8 - Unclamped Inductive Test Circuit

Outline Table



Outline Table



Tape & Reel Information

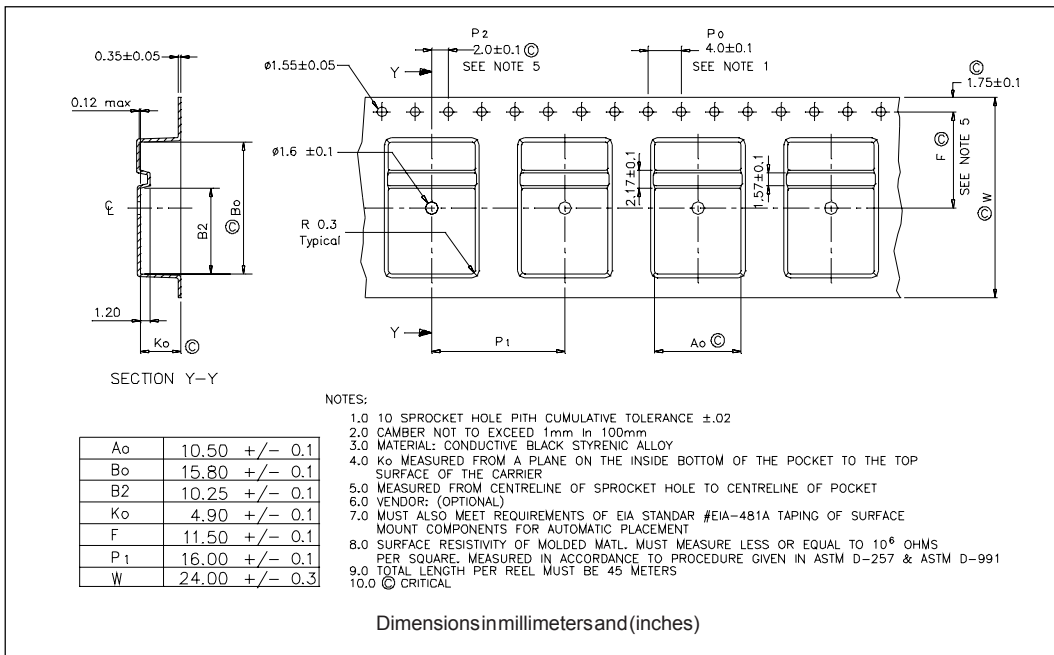

Part Marking Information

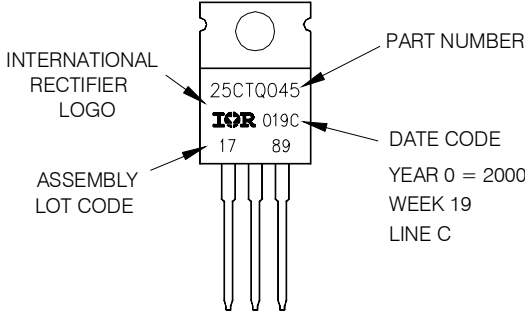
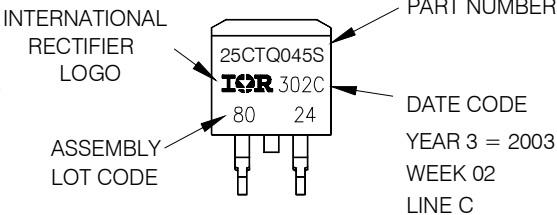
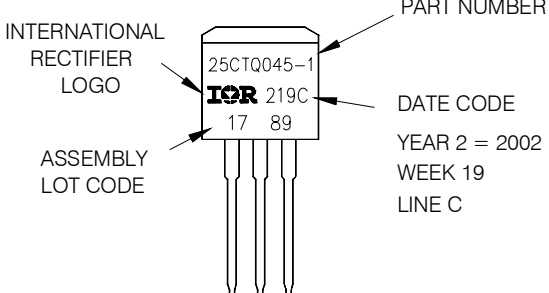
<p>TO-220</p>	<p>EXAMPLE: THIS IS A 25CTQ045                  LOT CODE 1789                  ASSEMBLED ON WW 19, 2000                  IN THE ASSEMBLY LINE "C"</p>	 <p>INTERNATIONAL RECTIFIER LOGO</p> <p>ASSEMBLY LOT CODE</p> <p>PART NUMBER</p> <p>DATE CODE                  YEAR 0 = 2000                  WEEK 19                  LINE C</p>
<p>D<sup>2</sup>PAK</p>	<p>EXAMPLE: THIS IS A 25CTQ045S                  LOT CODE 8024                  ASSEMBLED ON WW 02, 2003                  IN ASSEMBLY LINE "C"</p>	 <p>INTERNATIONAL RECTIFIER LOGO</p> <p>ASSEMBLY LOT CODE</p> <p>PART NUMBER</p> <p>DATE CODE                  YEAR 3 = 2003                  WEEK 02                  LINE C</p>
<p>TO-262</p>	<p>EXAMPLE: THIS IS A 25CTQ045-1                  LOT CODE 1789                  ASSEMBLED ON WW 19, 2002                  IN ASSEMBLY LINE "C"</p>	 <p>INTERNATIONAL RECTIFIER LOGO</p> <p>ASSEMBLY LOT CODE</p> <p>PART NUMBER</p> <p>DATE CODE                  YEAR 2 = 2002                  WEEK 19                  LINE C</p>

Ordering Information Table

Device Code	
	<b>25 C T Q 045 S TRL -</b>
	<div style="display: flex; justify-content: space-around; width: 100%;"> <span>①</span> <span>②</span> <span>③</span> <span>④</span> <span>⑤</span> <span>⑥</span> <span>⑦</span> <span>⑧</span> </div>
<b>1</b>	- Current Rating (30A)
<b>2</b>	- Circuit Configuration C = Common Cathode
<b>3</b>	- T = TO-220
<b>4</b>	- Schottky "Q" Series
<b>5</b>	- Voltage Ratings
<b>6</b>	- <ul style="list-style-type: none"> <li>• S = D<sup>2</sup>Pak</li> <li>• -1 = TO-262</li> </ul>
<b>7</b>	- <ul style="list-style-type: none"> <li>• none = Tube (50 pieces)</li> <li>• TRL = Tape &amp; Reel (Left Oriented - for D<sup>2</sup>Pak only)</li> <li>• TRR = Tape &amp; Reel (Right Oriented - for D<sup>2</sup>Pak only)</li> </ul>
<b>8</b>	- <ul style="list-style-type: none"> <li>• none = Standard Production</li> <li>• PbF = Lead-Free</li> </ul>

035 = 35V  
 040 = 40V  
 045 = 45V



```

25CTQ045
*****
* This model has been developed by *
* Wizard SPICE MODEL GENERATOR (1999) *
* (International Rectifier Corporation) *
* Contain Proprietary Information *
*****
* SPICE Model Diode is composed by a *
* simple diode plus paraladed VCG2T *
*****
.SUBCKT 25CTQ045 ANO CAT
D1 ANO 1 DMOD (0.07089)
*Define diode model
.MODEL DMOD D(IS=1.72789623043916E-04A,N=1.16449261507669,BV=52V,
+ IBV=0.347382965330896A,RS= 0.000623832,CJO=2.01681525450576E-08,
+ VJ=1.79426113441105,XTI=2, EG=0.778356513713514)
*****
*Implementation of VCG2T
VX 1 2 DC 0V
R1 2 CAT TRES 1E-6
.MODEL TRES RES(R=1,TC1=30.866905105089)
GP1 ANO CAT VALUE={-ABS(I(VX))*(EXP(((((-2.873853E-03/30.86691)*((V(2,CAT)*1E6)/(I(VX)+1E-6)-
1))+1)*5.486216E-02*ABS(V(ANO,CAT))))-1)}
*****
.ENDS 25CTQ045

Thermal Model Subcircuit
.SUBCKT 25CTQ045 5 1

CTHERM1 5 4 4.04E-01
CTHERM2 4 3 2.01E+00
CTHERM3 3 2 8.32E+00
CTHERM4 2 1 3.80E+02

R THERM1 5 4 1.62E+00
R THERM2 4 3 1.22E+00
R THERM1 3 2 3.50E-01
R THERM1 2 1 4.34E-02

.ENDS 25CTQ045
    
```

Data and specifications subject to change without notice.  
 This product has been designed and qualified for Industrial Level.  
 Qualification Standards can be found on IR's Web site.