

# 2SA1695

Silicon PNP Epitaxial Planar Transistor (Complement to type 2SC4468)

Application : Audio and General Purpose

**Absolute maximum ratings** (Ta=25°C)

Symbol	2SA1695	Unit
VcBo	-140	V
VcEO	-140	V
VEBO	-6	V
Ic	-10	A
IB	-4	A
Pc	100(Tc=25°C)	W
Tj	150	°C
Tstg	-55 to +150	°C

**Electrical Characteristics** (Ta=25°C)

Symbol	Conditions	2SA1695	Unit
IcBo	VcB=-140V	-10max	μA
IEBO	VEB=-6V	-10max	μA
V(BR)CEO	Ic=-50mA	-140min	V
hFE	VCE=-4V, Ic=-3A	50min*	
VCE(sat)	Ic=-5A, IB=-0.5A	-0.5max	V
fr	VCE=-12V, IE=0.5A	20typ	MHz
COB	VcB=-10V, f=1MHz	400typ	pF

\*hFE Rank ○(50 to 100), P(70 to 140), Y(90 to 180)

**Typical Switching Characteristics (Common Emitter)**

Vcc (V)	RL (Ω)	Ic (A)	VBB1 (V)	VBB2 (V)	IB1 (A)	IB2 (A)	ton (μs)	tstg (μs)	tf (μs)
-60	12	-5	-10	5	-0.5	0.5	0.17typ	1.86typ	0.27typ

**External Dimensions MT-100(TO3P)**

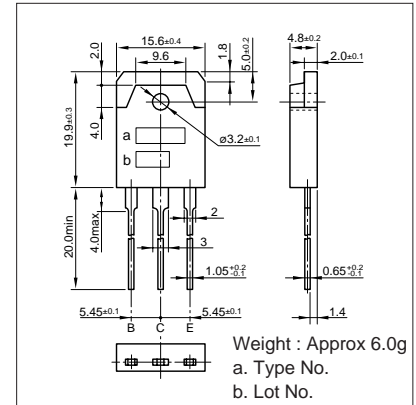

**Ic-VCE Characteristics (Typical)**

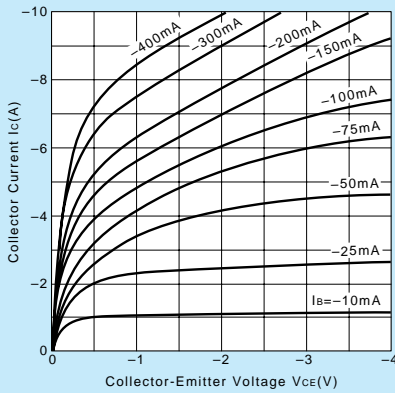

**VCE(sat)-IB Characteristics (Typical)**

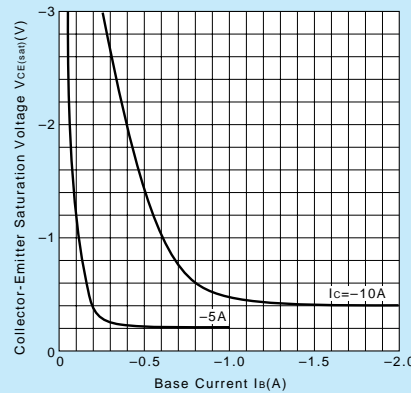

**Ic-VBE Temperature Characteristics (Typical)**

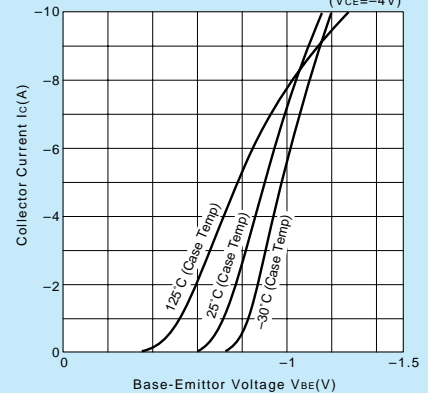

**hFE-Ic Characteristics (Typical)**

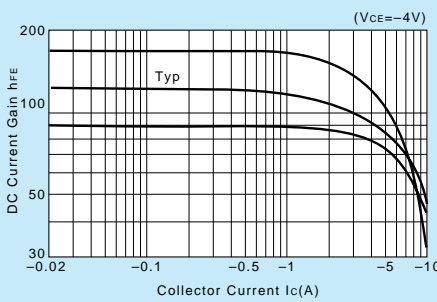

**hFE-Ic Temperature Characteristics (Typical)**

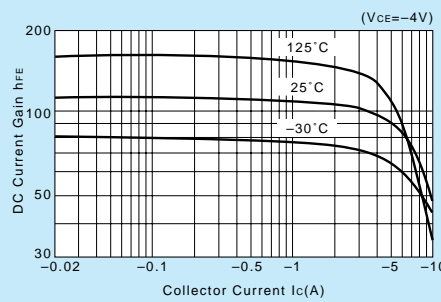

**θj-a-t Characteristics**

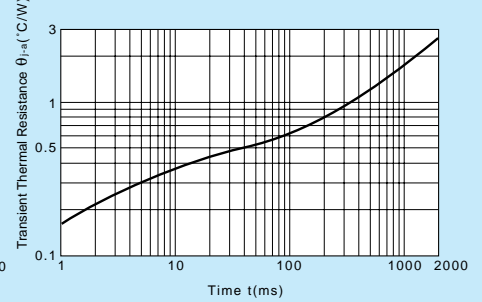

**fr-IE Characteristics (Typical)**

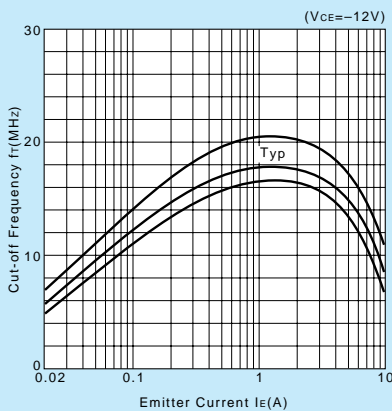

**Safe Operating Area (Single Pulse)**

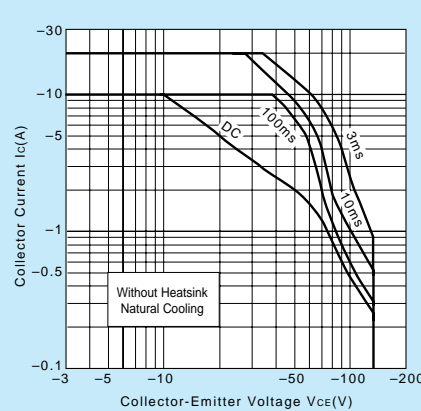

**Pc-Ta Derating**

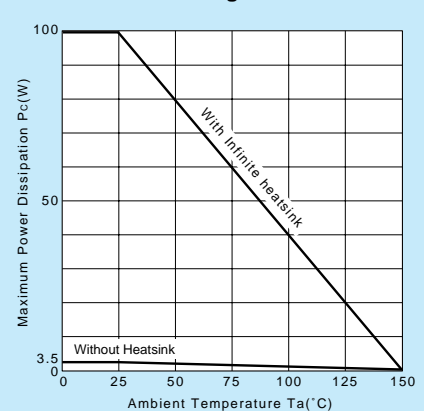

This datasheet has been downloaded from:

[www.DatasheetCatalog.com](http://www.DatasheetCatalog.com)

Datasheets for electronic components.