

Features

1. High current transfer ratio ($V_{CE0}:300V$ MIN)
(CTR:MIN.600% at $I_F=1mA$, $V_{ce}=2V$)
2. High isolation voltage between input and output
(Viso:5000Vrms).
3. Compact dual-in-line package.
4. Available package : DIP/ SMD/ H. (For Package Dimension please refer to page 82)

Applications

1. System appliances, measuring instruments.
2. Industrial robots.
3. Copiers, automatic vending machines.
4. Signal transmission between circuits of different potentials and impedances.
5. Telephone sets.
6. Copiers, facsimiles.
7. Interface with various power supply circuits, power distribution boards.
8. Numerical control machines.

Outside Dimension : Unit (mm)

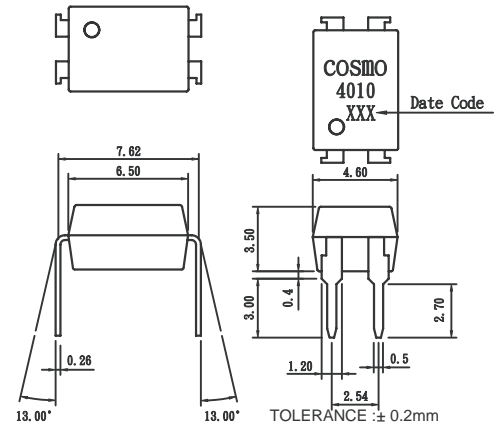

Schematic : Top View

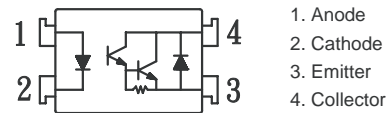

Absolute Maximum Ratings

($T_a=25^{\circ}C$)

Parameter		Symbol	Rating	Unit
Input	Forward current	I_F	50	mA
	Peak forward current	I_{FM}	1	A
	Reverse voltage	V_R	6	V
	Power dissipation	P_D	70	mW
Output	Collector-emitter voltage	V_{CE0}	300	V
	Emitter-collector voltage	V_{ECO}	0.1	V
	Collector current	I_C	150	mA
	Collector power dissipation	P_C	200	mW
Total power dissipation		P_{tot}	200	mW
Isolation voltage 1 minute		Viso	5000	Vrms
Operating temperature		T_{opr}	-30 to +100	$^{\circ}C$
Storage temperature		T_{stg}	-55 to +125	$^{\circ}C$
Soldering temperature 10 second		T_{sol}	260	$^{\circ}C$

Electro-optical Characteristics

($T_a=25^{\circ}C$)

Parameter		Symbol	Conditions	MIN.	TYP.	MAX.	Unit
Input	Forward voltage	V_F	$I_F=20mA$	—	1.2	1.4	V
	Peak forward voltage	V_{FM}	$I_{FM}=0.5A$	—	—	3.5	V
	Reverse current	I_R	$V_R=4V$	—	—	10	μA
	Terminal capacitance	C_t	$V=0, f=1kHz$	—	30	—	pF
Output	Collector dark current	I_{CEO}	$V_{CE}=200V, I_F=0$	—	—	1.0	μA
Transfer characteristics	Current transfer ratio	CTR	$I_F=1mA, V_{CE}=2V$	600	—	9000	%
	Collector-emitter saturation voltage	$V_{CE(sat)}$	$I_F=20mA, I_C=5mA$	—	—	1.5	V
	Isolation resistance	Riso	DC500V	5×10^{10}	—	—	ohm
	Floating capacitance	C_f	$V=0, f=1MHz$	—	0.6	1.0	pF
	Cut-off frequency	f_c	$V_{CC}=5V, I_C=2mA, R_L=100ohm$	—	7	—	kHz
	Response time (Rise)	t_r	$V_{CE}=2V, I_C=20mA, R_L=100ohm$	—	60	300	μs
	Response time (Fall)	t_f		—	50	250	μs

Classification table of current transfer ratio is shown below.

Model NO.	CTR (%)
*KP4010 A	600 TO 2000
KP4010 B	1500 TO 4000
KP4010 C	3000 TO 6000
*KP4010 D	5000 TO 9000
KP4010 E	600 TO 9000

*SPECIAL OPTION

Fig.1 Current Transfer Ratio vs. Forward Current

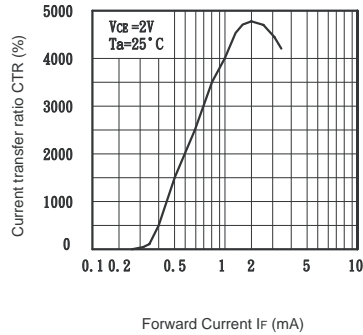

Fig.2 Collector Power Dissipation vs. Ambient Temperature

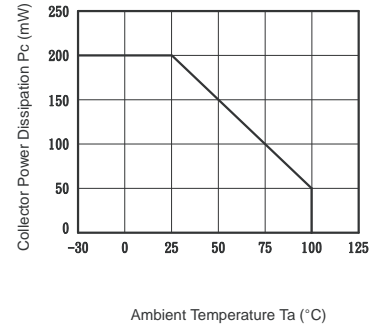

Fig.3 Collector Dark Current vs. Ambient Temperature

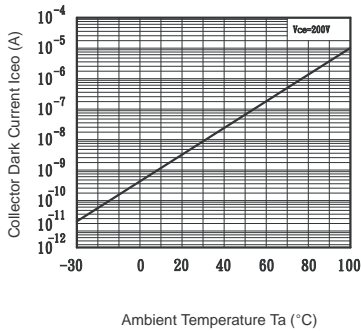

Fig.4 Forward Current vs. Ambient Temperature

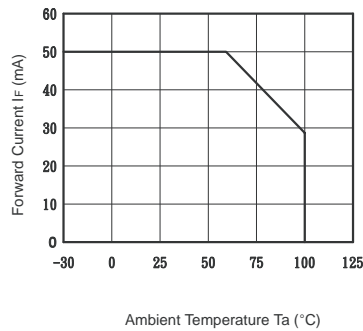

Fig.5 Forward Current vs. Forward Voltage

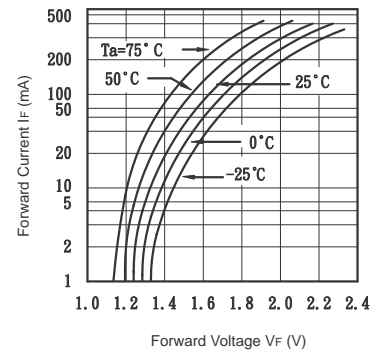

Fig.6 Collector Current vs. Collector-emitter Voltage

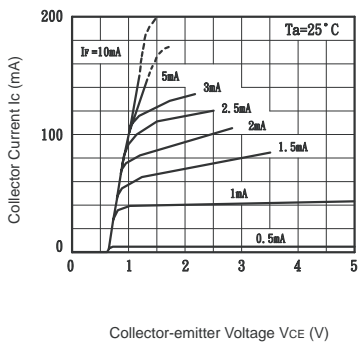

Fig.7 Relative Current Transfer Ratio vs. Ambient Temperature

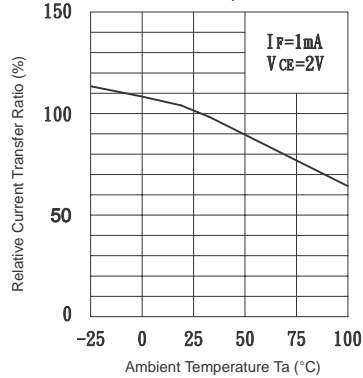

Fig.8 Collector-emitter Saturation Voltage vs. Forward Current

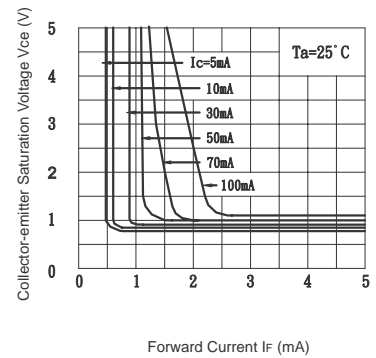
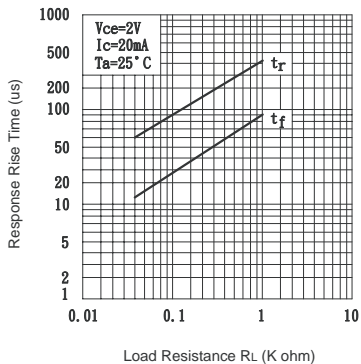

Fig.9 Response Time vs. Load Resistance



This datasheet has been download from:

www.datasheetcatalog.com

Datasheets for electronics components.