

TMP03/TMP04

FEATURES

- Low Cost 3-Pin Package
- Modulated Serial Digital Output
- Proportional to Temperature
- $\pm 1.5^{\circ}\text{C}$ Accuracy (typ) from -25°C to $+100^{\circ}\text{C}$
- Specified -40°C to $+100^{\circ}\text{C}$, Operation to 150°C
- Power Consumption 6.5 mW Max at 5 V
- Flexible Open-Collector Output on TMP03
- CMOS/TTL-Compatible Output on TMP04
- Low Voltage Operation (4.5 V to 7 V)

APPLICATIONS

- Isolated Sensors
- Environmental Control Systems
- Computer Thermal Monitoring
- Thermal Protection
- Industrial Process Control
- Power System Monitors

GENERAL DESCRIPTION

The TMP03/TMP04 are monolithic temperature detectors that generate a modulated serial digital output that varies in direct proportion to the temperature of the device. An onboard sensor generates a voltage precisely proportional to absolute temperature which is compared to an internal voltage reference and input to a precision digital modulator. The ratiometric encoding format of the serial digital output is independent of the clock drift errors common to most serial modulation techniques such as voltage-to-frequency converters. Overall accuracy is $\pm 1.5^{\circ}\text{C}$ (typical) from -25°C to $+100^{\circ}\text{C}$, with excellent transducer linearity. The digital output of the TMP04 is CMOS/TTL compatible, and is easily interfaced to the serial inputs of most popular microprocessors. The open-collector output of the TMP03 is capable of sinking 5 mA. The TMP03 is best suited for systems requiring isolated circuits utilizing optocouplers or isolation transformers.

The TMP03 and TMP04 are specified for operation at supply voltages from 4.5 V to 7 V. Operating from 5 V, supply current (unloaded) is less than 1.3 mA.

The TMP03/TMP04 are rated for operation over the -40°C to $+100^{\circ}\text{C}$ temperature range in the low cost TO-92, SO-8, and TSSOP-8 surface mount packages. Operation extends to 150°C with reduced accuracy.

(continued on page 4)

FUNCTIONAL BLOCK DIAGRAM

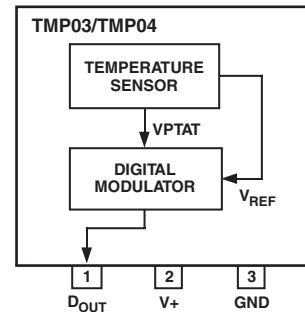

PACKAGE TYPES AVAILABLE

TO-92

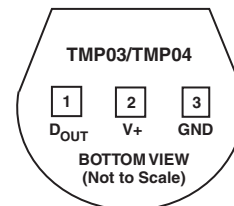

SO-8

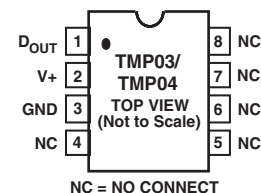

TMPO3/TMP04—SPECIFICATIONS

TMPO3F (V+ = 5 V, -40°C ≤ T_A ≤ 100°C, unless otherwise noted.)

Parameter	Symbol	Conditions	Min	Typ	Max	Unit
ACCURACY						
Temperature Error		-25°C < T _A < +100°C ¹		1.5	4.0	°C
		-40°C < T _A < -25°C ¹		2.0	5.0	°C
Temperature Linearity				0.5		°C
Long-Term Stability		1000 Hours at 125°C		0.5		°C
Nominal Mark-Space Ratio	T1/T2	T _A = 0°C		58.8		%
Nominal T1 Pulsewidth	T1			10		ms
Power Supply Rejection Ratio	PSRR	Over Rated Supply T _A = 25°C		0.7	1.4	°C/V
OUTPUTS						
Output Low Voltage	V _{OL}	I _{SINK} = 1.6 mA			0.2	V
Output Low Voltage	V _{OL}	I _{SINK} = 5 mA			2	V
		0°C < T _A < 100°C				
Output Low Voltage	V _{OL}	I _{SINK} = 4 mA			2	V
		-40°C < T _A < 0°C				
Digital Output Capacitance	C _{OUT}	(Note 2)		15		pF
Fall Time	t _{HL}	See Test Load		150		ns
Device Turn-On Time				20		ms
POWER SUPPLY						
Supply Range	V+		4.5		7	V
Supply Current	I _{SY}	Unloaded		0.9	1.3	mA

NOTES

¹Maximum deviation from output transfer function over specified temperature range.

²Guaranteed but not tested.

Specifications subject to change without notice.

Test Load

10 kΩ to 5 V Supply, 100 pF to Ground

TMPO4F (V+ = 5 V, -40°C ≤ T_A ≤ 100°C, unless otherwise noted.)

Parameter	Symbol	Conditions	Min	Typ	Max	Unit
ACCURACY						
Temperature Error		T _A = 25°C		1.0	3.0	°C
		-25°C < T _A < +100°C ¹		1.5	4.0	°C
		-40°C < T _A < -25°C ¹		2.0	5.0	°C
Temperature Linearity				0.5		°C
Long-Term Stability		1000 Hours at 125°C		0.5		°C
Nominal Mark-Space Ratio	T1/T2	T _A = 0°C		58.8		%
Nominal T1 Pulsewidth	T1			10		ms
Power Supply Rejection Ratio	PSRR	Over Rated Supply T _A = 25°C		0.7	1.2	°C/V
OUTPUTS						
Output High Voltage	V _{OH}	I _{OH} = 800 μA	V+ -0.4			V
Output Low Voltage	V _{OL}	I _{OL} = 800 μA			0.4	V
Digital Output Capacitance	C _{OUT}	(Note 2)		15		pF
Fall Time	t _{HL}	See Test Load		200		ns
Rise Time	t _{LH}	See Test Load		160		ns
Device Turn-On Time				20		ms
POWER SUPPLY						
Supply Range	V+		4.5		7	V
Supply Current	I _{SY}	Unloaded		0.9	1.3	mA

NOTES

¹Maximum deviation from output transfer function over specified temperature range.

²Guaranteed but not tested.

Specifications subject to change without notice.

Test Load

100 pF to Ground

TMP03/TMP04

ABSOLUTE MAXIMUM RATINGS*

Maximum Supply Voltage	9 V
Maximum Output Current (TMP03 D _{OUT})	50 mA
Maximum Output Current (TMP04 D _{OUT})	10 mA
Maximum Open-Collector Output Voltage (TMP03)	18 V
Operating Temperature Range	-55°C to +150°C
Dice Junction Temperature	175°C
Storage Temperature Range	-65°C to +160°C
Lead Temperature (Soldering, 60 sec)	300°C

*CAUTION

¹Stresses above those listed under Absolute Maximum Ratings may cause permanent damage to the device. This is a stress rating only; functional operation at or above this specification is not implied. Exposure to the above maximum rating conditions for extended periods may affect device reliability.

²Digital inputs and outputs are protected, however, permanent damage may occur on unprotected units from high-energy electrostatic fields. Keep units in conductive foam or packaging at all times until ready to use. Use proper antistatic handling procedures.

³Remove power before inserting or removing units from their sockets.

Package Type	θ_{JA}	θ_{JC}	Units
T-3-1	162 ¹	120	°C/W
R-8	158 ¹	43	°C/W

NOTE

¹ θ_{JA} is specified for device in socket (worst case conditions).

ORDERING GUIDE

Model ¹	Temperature Range	Package Description	Package Option
TMP03FS	-40°C to +85°C	8-Lead SOIC_N	R-8
TMP03FSZ	-40°C to +85°C	8-Lead SOIC_N	R-8
TMP03FSZ-REEL	-40°C to +85°C	8-Lead SOIC_N	R-8
TMP03FT9	-40°C to +85°C	3-Lead TO-92	T-3-1
TMP03FT9Z	-40°C to +85°C	3-Lead TO-92	T-3-1
TMP04FS	-40°C to +85°C	8-Lead SOIC_N	R-8
TMP04FS-REEL	-40°C to +85°C	8-Lead SOIC_N	R-8
TMP04FSZ	-40°C to +85°C	8-Lead SOIC_N	R-8
TMP04FSZ-REEL	-40°C to +85°C	8-Lead SOIC_N	R-8
TMP04FT9	-40°C to +85°C	3-Lead TO-92	T-3-1
TMP04FT9Z	-40°C to +85°C	3-Lead TO-92	T-3-1

¹ Z = RoHS Compliant Part.

CAUTION

ESD (electrostatic discharge) sensitive device. Electrostatic charges as high as 4000 V readily accumulate on the human body and test equipment and can discharge without detection. Although the TMP03 features proprietary ESD protection circuitry, permanent damage may occur on devices subjected to high-energy electrostatic discharges. Therefore, proper ESD precautions are recommended to avoid performance degradation or loss of functionality.



TMP03/TMP04

(continued from page 1)

The TMP03 is a powerful, complete temperature measurement system with digital output, on a single chip. The onboard temperature sensor follows in the footsteps of the TMP01 low power programmable temperature controller, offering excellent accuracy and linearity over the entire rated temperature range without correction or calibration by the user.

The sensor output is digitized by a first-order sigma-delta modulator, also known as the “charge balance” type analog-to-digital converter. (See Figure 1.) This type of converter utilizes time-domain oversampling and a high accuracy comparator to deliver 12 bits of effective accuracy in an extremely compact circuit.

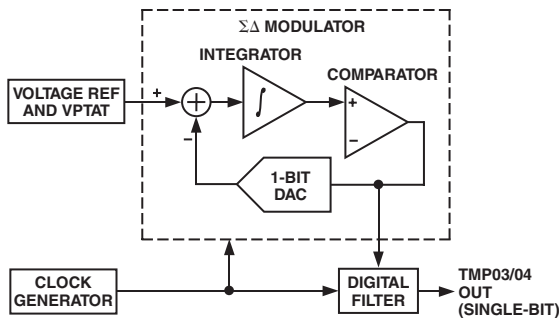

Figure 1. TMP03 Block Diagram Showing First-Order Sigma-Delta Modulator

Basically, the sigma-delta modulator consists of an input sampler, a summing network, an integrator, a comparator, and a 1-bit DAC. Similar to the voltage-to-frequency converter, this architecture creates in effect a negative feedback loop whose intent is to minimize the integrator output by changing the duty cycle of the comparator output in response to input voltage changes. The comparator samples the output of the integrator at a much higher rate than the input sampling frequency, called oversampling. This spreads the quantization noise over a much wider band than that of the input signal, improving overall noise performance and increasing accuracy.

The modulated output of the comparator is encoded using a circuit technique which results in a serial digital signal with a mark-space ratio format that is easily decoded by any microprocessor into either degrees centigrade or degrees Fahrenheit values, and readily transmitted or modulated over a single wire. Most importantly, this encoding method neatly

avoids major error sources common to other modulation techniques, as it is clock-independent.

Output Encoding

Accurate sampling of an analog signal requires precise spacing of the sampling interval in order to maintain an accurate representation of the signal in the time domain. This dictates a master clock between the digitizer and the signal processor. In the case of compact, cost-effective data acquisition systems, the addition of a buffered, high speed clock line can represent a significant burden on the overall system design. Alternatively, the addition of an onboard clock circuit with the appropriate accuracy and drift performance to an integrated circuit can add significant cost. The modulation and encoding techniques utilized in the TMP03 avoid this problem and allow the overall circuit to fit into a compact, 3-pin package. To achieve this, a simple, compact onboard clock and an oversampling digitizer that is insensitive to sampling rate variations are used. Most importantly, the digitized signal is encoded into a ratiometric format in which the exact frequency of the TMP03’s clock is irrelevant, and the effects of clock variations are effectively canceled upon decoding by the digital filter.

The output of the TMP03 is a square wave with a nominal frequency of 35 Hz ($\pm 20\%$) at 25°C. The output format is readily decoded by the user as follows:



Figure 2. TMP03 Output Format

$$\text{Temperature } (^{\circ}\text{C}) = 235 - \left(\frac{400 \times T1}{T2} \right)$$

$$\text{Temperature } (^{\circ}\text{F}) = 455 - \left(\frac{720 \times T1}{T2} \right)$$

The time periods T1 (high period) and T2 (low period) are values easily read by a microprocessor timer/counter port, with the above calculations performed in software. Since both periods are obtained consecutively, using the same clock, performing the division indicated in the above formulas results in a ratiometric value that is independent of the exact frequency of, or drift in, either the originating clock of the TMP03 or the user’s counting clock.

Table I. Counter Size and Clock Frequency Effects on Quantization Error

Maximum Count Available	Maximum Temp Required	Maximum Frequency	Quantization Error (25°C)	Quantization Error (77°F)
4096	125°C	94 kHz	0.284°C	0.512°F
8192	125°C	188 kHz	0.142°C	0.256°F
16384	125°C	376 kHz	0.071°C	0.128°F

Optimizing Counter Characteristics

Counter resolution, clock rate, and the resultant temperature decode error that occurs using a counter scheme may be determined from the following calculations:

1. T1 is nominally 10 ms, and compared to T2 is relatively insensitive to temperature changes. A useful worst-case assumption is that T1 will never exceed 12 ms over the specified temperature range.

$$T1 \text{ max} = 12 \text{ ms}$$

Substituting this value for T1 in the formula, temperature (°C) = 235 - ([T1/T2] × 400), yields a maximum value of T2 of 44 ms at 125°C. Rearranging the formula allows the maximum value of T2 to be calculated at any maximum operating temperature:

$$T2 \text{ (Temp)} = (T1 \text{ max} \times 400) / (235 - \text{Temp}) \text{ in seconds}$$

2. We now need to calculate the maximum clock frequency we can apply to the gated counter so it will not overflow during T2 time measurement. The maximum frequency is calculated using:

$$\text{Frequency (max)} = \text{Counter Size} / (T2 \text{ at maximum temperature})$$

Substituting in the equation using a 12-bit counter gives, Fmax = 4096/44 ms ≈ 94 kHz.

3. Now we can calculate the temperature resolution, or quantization error, provided by the counter at the chosen clock frequency and temperature of interest. Again, using a 12-bit counter being clocked at 90 kHz (to allow for ~5% temperature over-range), the temperature resolution at 25°C is calculated from:

$$\text{Quantization Error (°C)} = 400 \times ([\text{Count1}/\text{Count2}] - [\text{Count1} - 1]/[\text{Count2} + 1])$$

$$\text{Quantization Error (°F)} = 720 \times ([\text{Count1}/\text{Count2}] - [\text{Count1} - 1]/[\text{Count2} + 1])$$

where, Count1 = T1max × Frequency, and Count2 = T2 (Temp) × Frequency. At 25°C this gives a resolution of better than 0.3°C. Note that the temperature resolution calculated from these equations improves as temperature increases. Higher temperature resolution will be obtained by employing larger counters as shown in Table I. The internal quantization error of the TMP03 sets a theoretical minimum resolution of approximately 0.1°C at 25°C.

Self-Heating Effects

The temperature measurement accuracy of the TMP03 may be degraded in some applications due to self-heating. Errors introduced are from the quiescent dissipation, and power dissipated by the digital output. The magnitude of these temperature errors is dependent on the thermal conductivity of the TMP03 package, the mounting technique, and effects of airflow. Static dissipation in the TMP03 is typically 4.5 mW operating at 5 V

with no load. In the TO-92 package mounted in free air, this accounts for a temperature increase due to self-heating of

$$\Delta T = P_{DISS} \times \theta_{JA} = 4.5 \text{ mW} \times 162^\circ\text{C}/\text{W} = 0.73^\circ\text{C} \text{ (1.3}^\circ\text{F)}$$

For a free-standing surface-mount TSSOP package, the temperature increase due to self-heating would be

$$\Delta T = P_{DISS} \times \theta_{JA} = 4.5 \text{ mW} \times 240^\circ\text{C}/\text{W} = 1.08^\circ\text{C} \text{ (1.9}^\circ\text{F)}$$

In addition, power is dissipated by the digital output which is capable of sinking 800 μA continuous (TMP04). Under full load, the output may dissipate

$$P_{DISS} = (0.6 \text{ V})(0.8 \text{ mA}) \left(\frac{T2}{T1 + T2} \right)$$

For example, with T2 = 20 ms and T1 = 10 ms, the power dissipation due to the digital output is approximately 0.32 mW with a 0.8 mA load. In a free-standing TSSOP package, this accounts for a temperature increase due to output self-heating of

$$\Delta T = P_{DISS} \times \theta_{JA} = 0.32 \text{ mW} \times 240^\circ\text{C}/\text{W} = 0.08^\circ\text{C} \text{ (0.14}^\circ\text{F)}$$

This temperature increase adds directly to that from the quiescent dissipation and affects the accuracy of the TMP03 relative to the true ambient temperature. Alternatively, when the same package has been bonded to a large plate or other thermal mass (effectively a large heatsink) to measure its temperature, the total self-heating error would be reduced to approximately

$$\Delta T = P_{DISS} \times \theta_{JC} = (4.5 \text{ mW} + 0.32 \text{ mW}) \times 43^\circ\text{C}/\text{W} = 0.21^\circ\text{C} \text{ (0.37}^\circ\text{F)}$$

Calibration

The TMP03 and TMP04 are laser-trimmed for accuracy and linearity during manufacture and, in most cases, no further adjustments are required. However, some improvement in performance can be gained by additional system calibration. To perform a single-point calibration at room temperature, measure the TMP03 output, record the actual measurement temperature, and modify the offset constant (normally 235; see the Output Encoding section) as follows:

$$\text{Offset Constant} = 235 + (T_{OBSERVED} - T_{TMP03OUTPUT})$$

A more complicated 2-point calibration is also possible. This involves measuring the TMP03 output at two temperatures, Temp1 and Temp2, and modifying the slope constant (normally 400) as follows:

$$\text{Slope Constant} = \frac{\text{Temp2} - \text{Temp1}}{\left(\frac{T1 \text{ @ Temp1}}{T2 \text{ @ Temp1}} \right) - \left(\frac{T1 \text{ @ Temp2}}{T2 \text{ @ Temp2}} \right)}$$

where T1 and T2 are the output high and output low times, respectively.

TMP03/TMP04—Typical Performance Characteristics

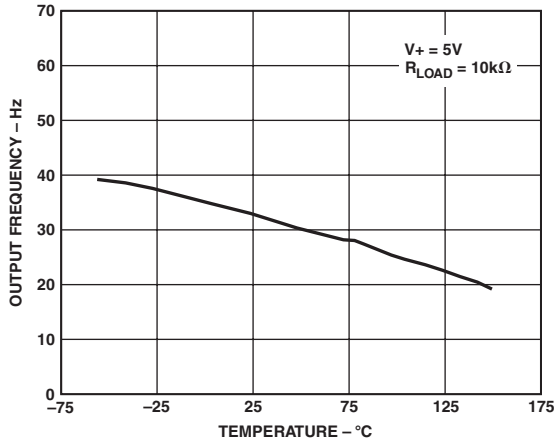

TPC 1. Output Frequency vs. Temperature

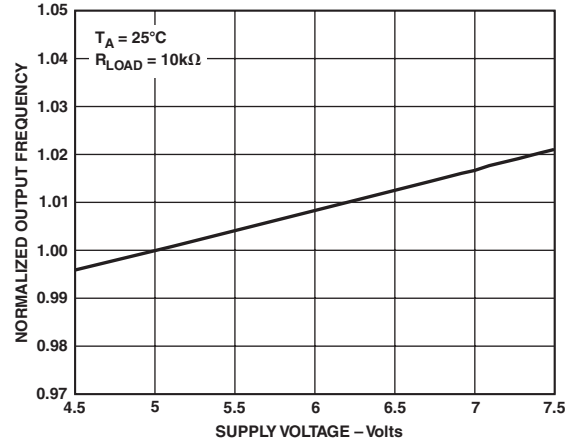

TPC 4. Normalized Output Frequency vs. Supply Voltage

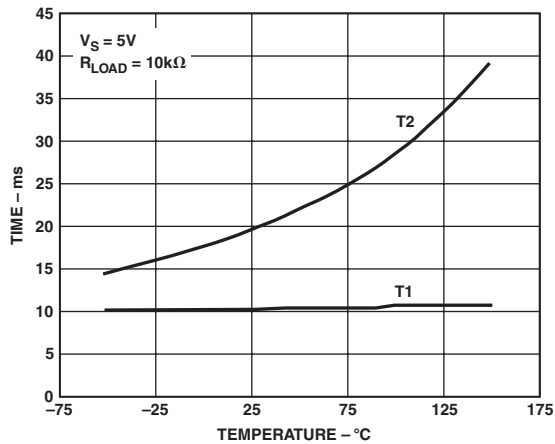

TPC 2. T1 and T2 Times vs. Temperature

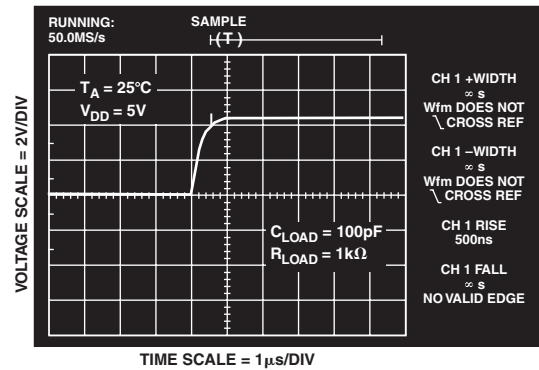

TPC 5. TMP03 Output Rise Time at 25°C

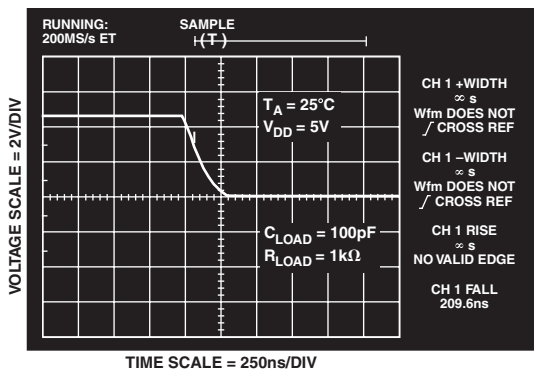

TPC 3. TMP03 Output Fall Time at 25°C

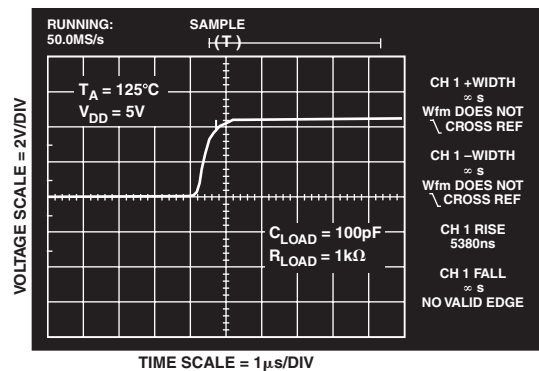

TPC 6. TMP03 Output Rise Time at 125°C

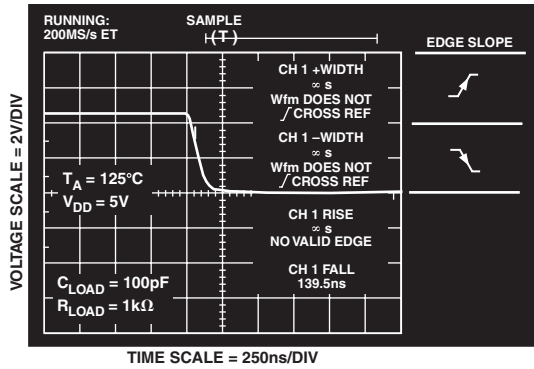

TPC 7. TMP03 Output Fall Time at 125°C

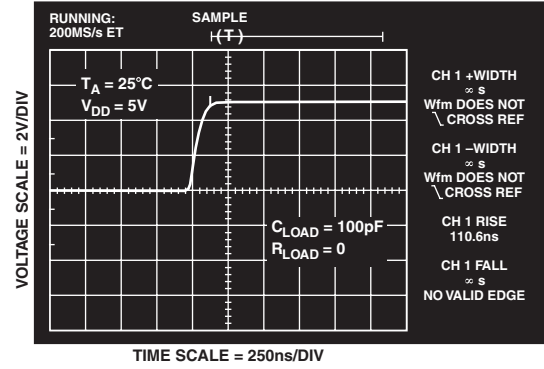

TPC 10. TMP04 Output Rise Time at 25°C

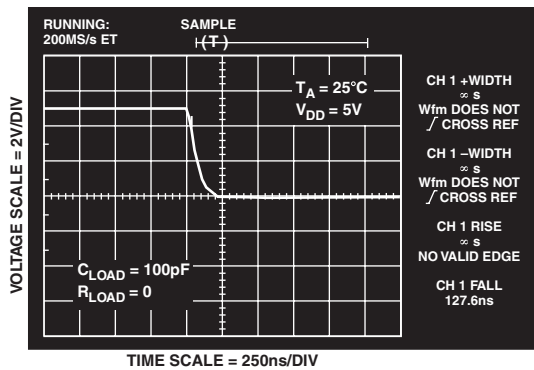

TPC 8. TMP04 Output Fall Time at 25°C

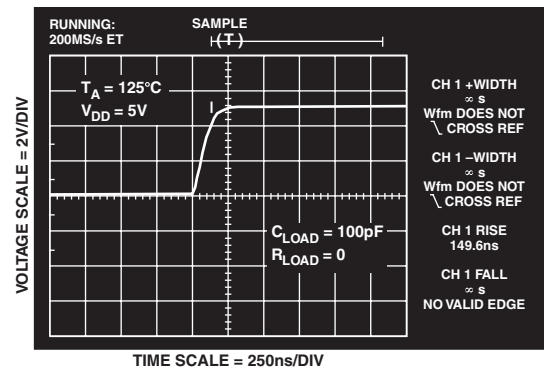

TPC 11. TMP04 Output Rise Time at 125°C

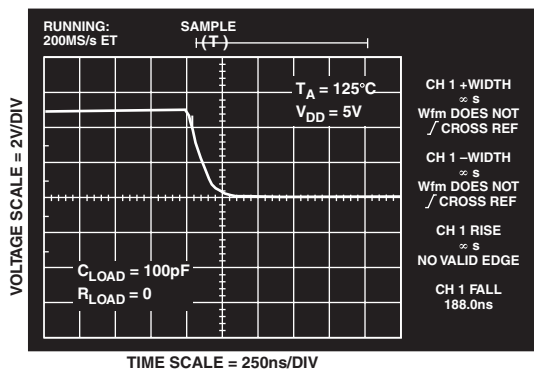

TPC 9. TMP04 Output Fall Time at 125°C

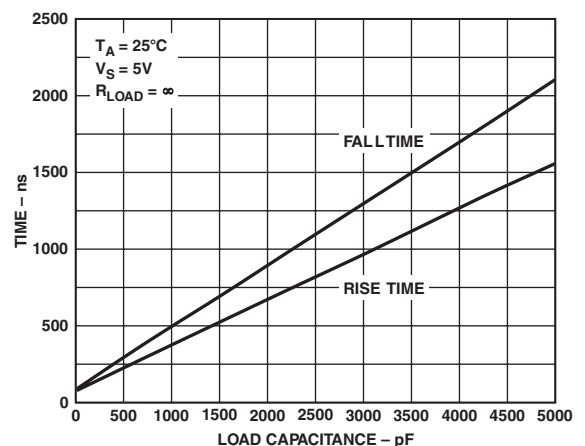

TPC 12. TMP04 Output Rise and Fall Times vs. Capacitive Load

TMP03/TMP04

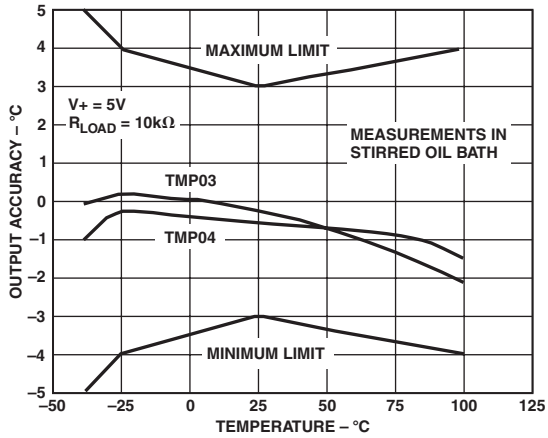

TPC 13. Output Accuracy vs. Temperature

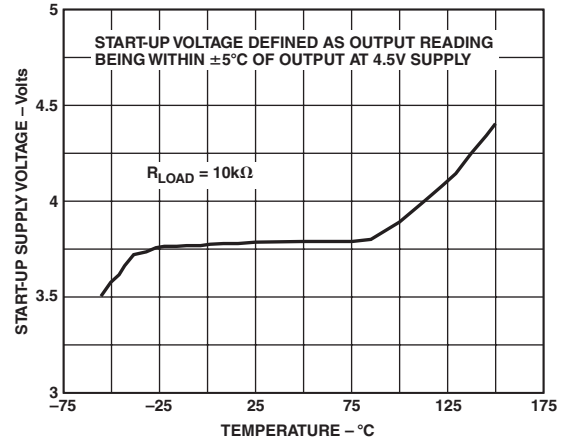

TPC 16. Start-Up Voltage vs. Temperature

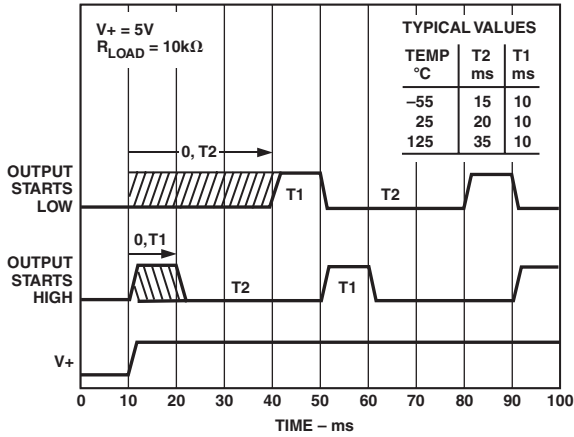

TPC 14. Start-Up Response

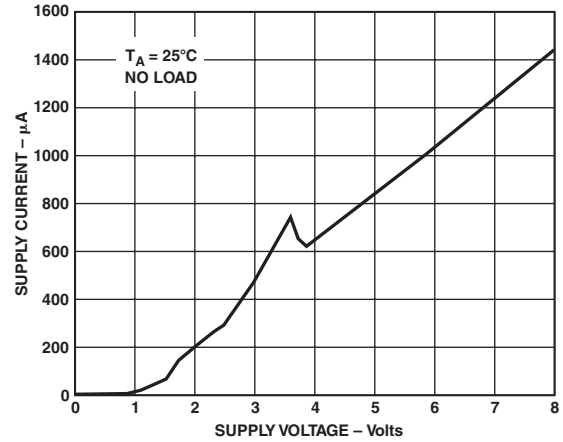

TPC 17. Supply Current vs. Supply Voltage

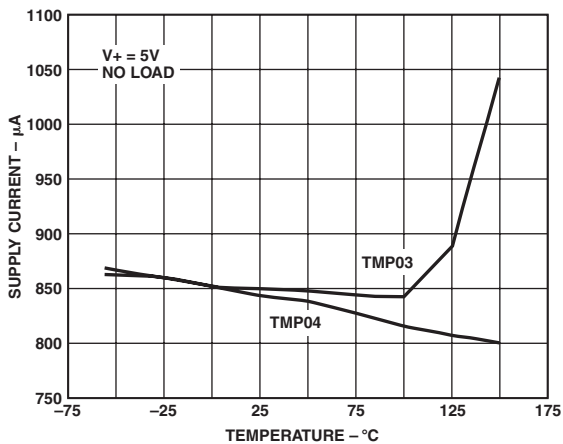

TPC 15. Supply Current vs. Temperature

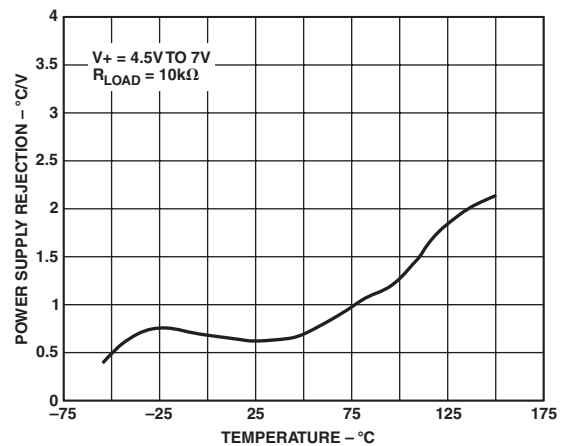

TPC 18. Power Supply Rejection vs. Temperature

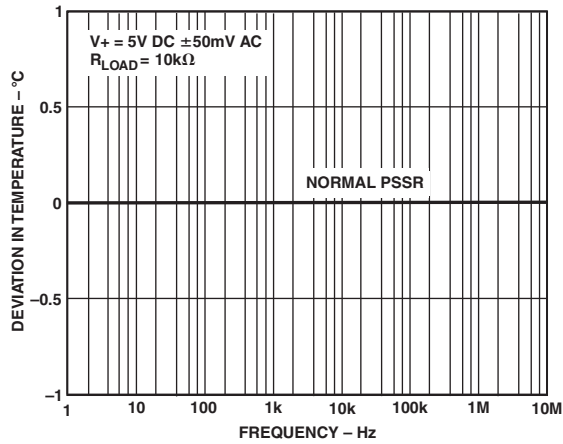

TPC 19. Power Supply Rejection vs. Frequency

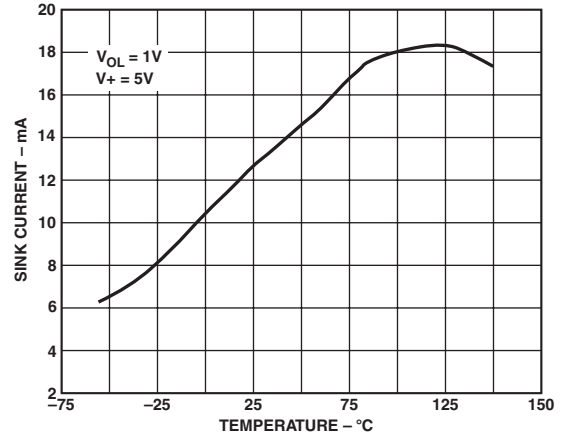

TPC 22. TMP03 Open-Collector Sink Current vs. Temperature

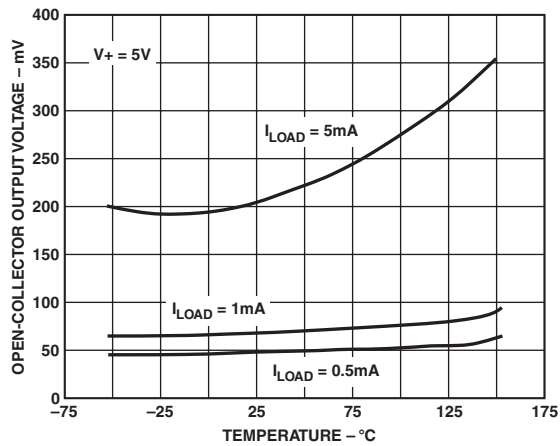

TPC 20. TMP03 Open-Collector Output Voltage vs. Temperature

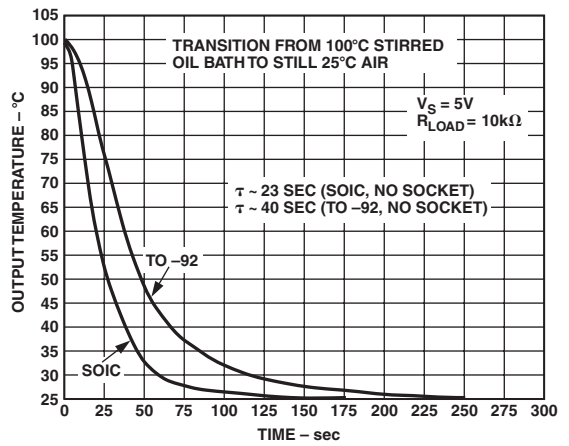

TPC 23. Thermal Response Time in Still Air

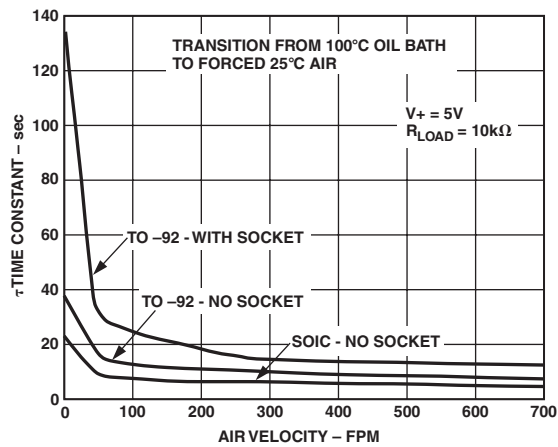

TPC 21. Thermal Time Constant in Forced Air

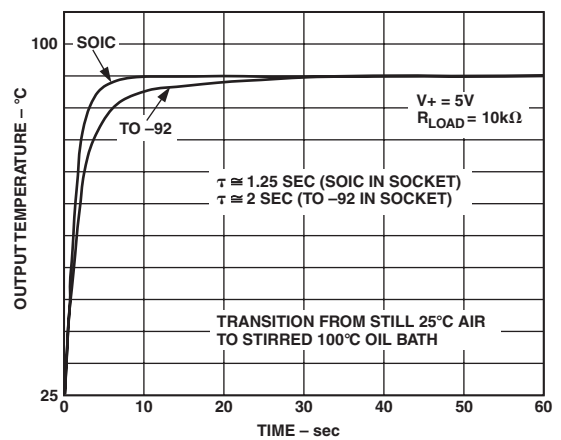

TPC 24. Thermal Response Time in Stirred Oil Bath

TMP03/TMP04

APPLICATIONS INFORMATION

Supply Bypassing

Precision analog products, such as the TMP03, require a well-filtered power source. Since the TMP03 operate from a single 5 V supply, it seems convenient to simply tap into the digital logic power supply. Unfortunately, the logic supply is often a switch-mode design, which generates noise in the 20 kHz to 1 MHz range. In addition, fast logic gates can generate glitches hundred of millivolts in amplitude due to wiring resistance and inductance.

If possible, the TMP03 should be powered directly from the system power supply. This arrangement, shown in Figure 3, will isolate the analog section from the logic switching transients. Even if a separate power supply trace is not available, however, generous supply bypassing will reduce supply-line induced errors. Local supply bypassing consisting of a 10 μF tantalum electrolytic in parallel with a 0.1 μF ceramic capacitor is recommended (Figure 4a).

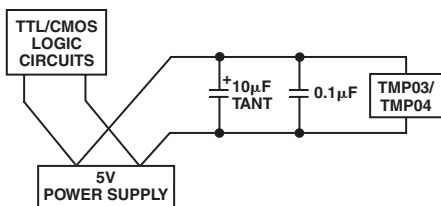

Figure 3. Use Separate Traces to Reduce Power Supply Noise

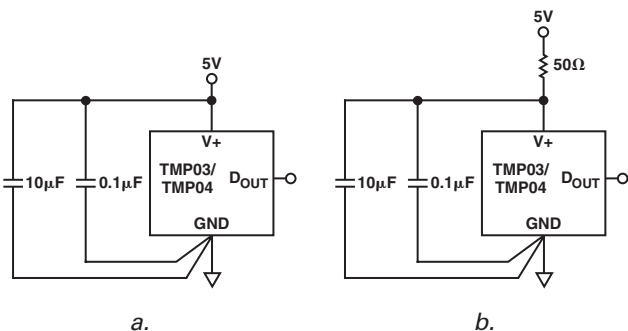

Figure 4. Recommended Supply Bypassing for the TMP03

The quiescent power supply current requirement of the TMP03 is typically only 900 μA . The supply current will not change appreciably when driving a light load (such as a CMOS gate), so a simple RC filter can be added to further reduce power supply noise (Figure 4b).

TMP03 Output Configurations

The TMP03 (Figure 5a) has an open-collector NPN output which is suitable for driving a high current load, such as an opto-isolator. Since the output source current is set by the pull-up resistor, output capacitance should be minimized in TMP03 applications. Otherwise, unequal rise and fall times will skew the pulsewidth and introduce measurement errors. The NPN transistor has a breakdown voltage of 18 V.

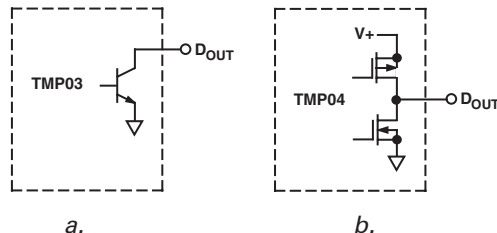

Figure 5. TMP03 Digital Output Structure

The TMP04 has a “totem-pole” CMOS output (Figure 5b) and provides rail-to-rail output drive for logic interfaces. The rise and fall times of the TMP04 output are closely matched, so that errors caused by capacitive loading are minimized. If load capacitance is large, for example when driving a long cable, an external buffer may improve accuracy. See the “Remote Temperature Measurement” section of this data sheet for suggestions.

Interfacing the TMP03 to Low Voltage Logic

The TMP03’s open-collector output is ideal for driving logic gates that operate from low supply voltages, such as 3.3 V. As shown in Figure 6, a pull-up resistor is connected from the low voltage logic supply (2.9 V, 3 V, etc.) to the TMP03 output. Current through the pull-up resistor should be limited to about 1 mA, which will maintain an output LOW logic level of <200 mV.

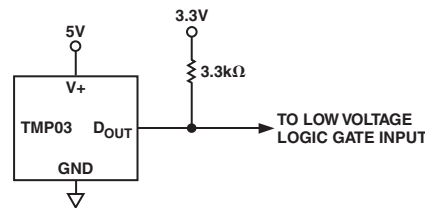
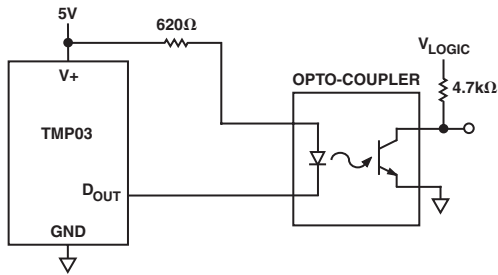

Figure 6. Interfacing to Low Voltage Logic

Remote Temperature Measurement

When measuring a temperature in situations where high common-mode voltages exist, an opto-isolator can be used to isolate the output (Figure 7a). The TMP03 is recommended in this application because its open-collector NPN transistor has a higher current sink capability than the CMOS output of the TMP04. To maintain the integrity of the measurement, the opto-isolator must have relatively equal turn-on and turn-off times. Some Darlington opto-isolators, such as the 4N32, have a turn-off time that is much longer than their turn-on time. In this case, the T1 time will be longer than T2, and an erroneous reading will result. A PNP transistor can be used to provide greater current drive to the opto-isolator (Figure 7b). An opto-isolator with an integral logic gate output, such as the H11L1 from Quality Technology, can also be used (Figure 8).



a.

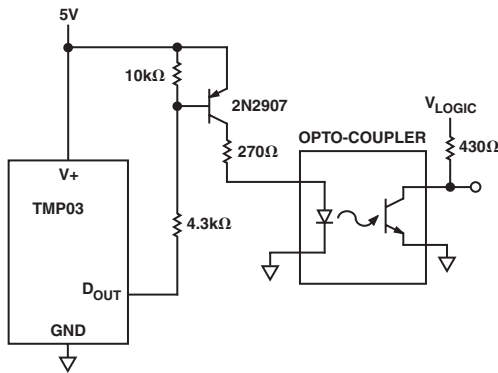

b.

Figure 7. Optically Isolating the Digital Output

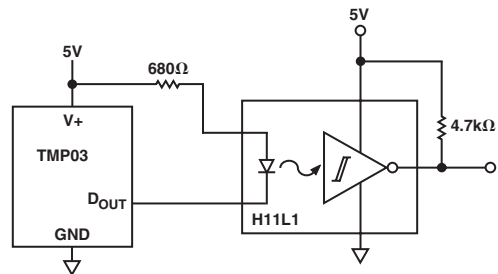

Figure 8. An Opto-Isolator with Schmitt Trigger Logic Gate Improves Output Rise and Fall Times

The TMP03 and TMP04 are superior to analog-output transducers for measuring temperature at remote locations, because the digital output provides better noise immunity than an analog signal. When measuring temperature at a remote location, the ratio of the output pulses must be maintained. To maintain the integrity of the pulsewidth, an external buffer can be added. For example, adding a differential line driver such as the ADM485 permits precise temperature measurements at distances up to 4000 ft. (Figure 9). The ADM485 driver and receiver skew is only 5 ns maximum, so the TMP04 duty cycle is not degraded. Up to 32 ADM485s can be multiplexed onto one line by providing additional decoding.

As previously mentioned, the digital output of the TMP03 provides excellent noise immunity in remote measurement applications. The user should be aware, however, that heat from an external cable can be conducted back to the TMP03. This heat conduction through the connecting wires can influence the temperature of the TMP03. If large temperature differences exist within the sensor environment, an opto-isolator, level shifter or other thermal barrier can be used to minimize measurement errors.

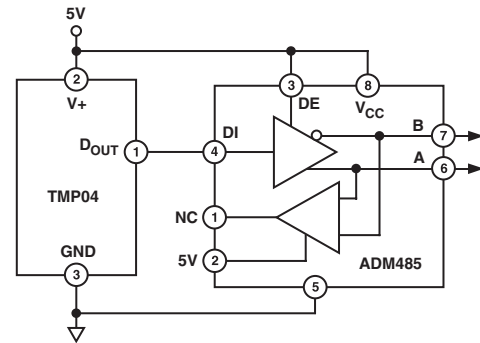

Figure 9. A Differential Line Driver for Remote Temperature Measurement

Microcomputer Interfaces

The TMP03 output is easily decoded with a microcomputer. The microcomputer simply measures the T1 and T2 periods in software or hardware, and then calculates the temperature using the equation in the Output Encoding section of this data sheet. Since the TMP03's output is ratiometric, precise control of the counting frequency is not required. The only timing requirements are that the clock frequency be high enough to provide the required measurement resolution (see the Output Encoding section for details) and that the clock source be stable. The ratiometric output of the TMP03 is an advantage because the microcomputer's crystal clock frequency is often dictated by the serial baud rate or other timing considerations.

Pulsewidth timing is usually done with the microcomputer's on-chip timer. A typical example, using the 80C51, is shown in Figure 10. This circuit requires only one input pin on the microcomputer, which highlights the efficiency of the TMP04's pulsewidth output format. Traditional serial input protocols, with data line, clock and chip select, usually require three or more I/O pins.

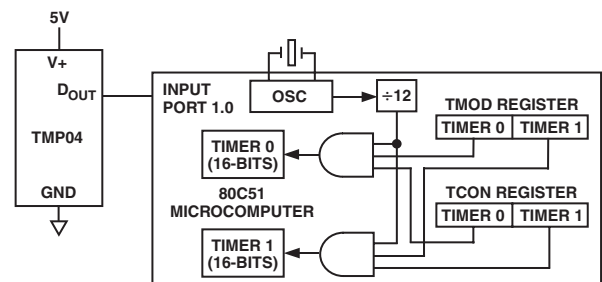

Figure 10. A TMP04 Interface to the 80C51 Microcomputer

The 80C51 has two 16-bit timers. The clock source for the timers is the crystal oscillator frequency divided by 12. Thus, a crystal frequency of 12 MHz or greater will provide resolution of 1 μs or less.

The 80C51 timers are controlled by two dedicated registers. The TMOD register controls the timer mode of operation, while TCON controls the start and stop times. Both the TMOD and TCON registers must be set to start the timer.

TMP03/TMP04

Software for the interface is shown in Listing 1. The program monitors the TMP04 output, and turns the counters on and off to measure the duty cycle. The time that the output is high is mea-

sured by Timer 0, and the time that the output is low is measured by Timer 1. When the routine finishes, the results are available in Special Function Registers (SFRs) 08AH through 08DH.

Listing 1. An 80C51 Software Routine for the TMP04

```
;
; Test of a TMP04 interface to the 8051,
; using timer 0 and timer 1 to measure the duty cycle
;
; This program has three steps:
; 1. Clear the timer registers, then wait for a low-to-
;    high transition on input P1.0 (which is connected
;    to the output of the TMP04).
; 2. When P1.0 goes high, timer 0 starts. The program
;    then loops, testing P1.0.
; 3. When P1.0 goes low, timer 0 stops & timer 1 starts. The
;    program loops until P1.0 goes low, when timer 1 stops
;    and the TMP04's T1 and T2 values are stored in Special
;    Function registers 8AH through 8DH (TL0 through TH1).
;
;
; Primary controls
$MOD51
$TITLE(TMP04 Interface, Using T0 and T1)
$PAGEWIDTH(80)
$DEBUG
$OBJECT
;
; Variable declarations
;
PORT1          DATA          90H          ;SFR register for port 1
;TCON          DATA          88H          ;timer control
;TMOD          DATA          89H          ;timer mode
;TH0           DATA          8CH          ;timer 0 hi byte
;TH1           DATA          8DH          ;timer 1 hi byte
;TL0           DATA          8AH          ;timer 0 lo byte
;TL1           DATA          8BH          ;timer 1 low byte
;
;
;          ORG          100H          ;arbitrary start
;
READ_TMP04:    MOV          A,#00          ;clear the
               MOV          TH0,A          ; counters
               MOV          TH1,A          ; first
               MOV          TL0,A          ;
               MOV          TL1,A          ;
WAIT_LO:       JB          PORT1.0,WAIT_LO ;wait for TMP04 output to go low
               MOV          A,#11H          ;get ready to start timer0
               MOV          TMOD,A
WAIT_HI:       JNB         PORT1.0,WAIT_HI ;wait for output to go high
;
;Timer 0 runs while TMP04 output is high
;
               SETB         TCON.4          ;start timer 0
WAITTIMER0:    JB          PORT1.0,WAITTIMER0
               CLR          TCON.4          ;shut off timer 0
;
;Timer 1 runs while TMP04 output is low
;
               SETB         TCON.6          ;start timer 1
WAITTIMER1:    JNB         PORT1.0,WAITTIMER1
               CLR          TCON.6          ;stop timer 1
               MOV          A,#0H          ;get ready to disable timers
               MOV          TMOD,A
               RET
               END
```

When the READ_TMP04 routine is called, the counter registers are cleared. The program sets the counters to their 16-bit mode, and then waits for the TMP04 output to go high. When the input port returns a logic high level, Timer 0 starts. The timer continues to run while the program monitors the input port. When the TMP04 output goes low, Timer 0 stops and Timer 1 starts. Timer 1 runs until the TMP04 output goes high, at which time the TMP04 interface is complete. When the subroutine ends, the timer values are stored in their respective SFRs and the TMP04's temperature can be calculated in software.

Since the 80C51 operates asynchronously to the TMP04, there is a delay between the TMP04 output transition and the start of the timer. This delay can vary between 0 μ s and the execution time of the instruction that recognized the transition. The 80C51's "jump on port.bit" instructions (JB and JNB) require 24 clock cycles for execution. With a 12 MHz clock, this produces an uncertainty of 2 μ s (24 clock cycles/12 MHz) at each transition of the TMP04 output. The worst case condition occurs when T1 is 4 μ s shorter than the actual value and T2 is 4 μ s longer. For a 25°C reading ("room temperature"), the nominal error caused by the 2 μ s delay is only about $\pm 0.15^\circ\text{C}$.

The TMP04 is also easily interfaced to digital signal processors (DSPs), such as the ADSP210x series. Again, only a single I/O pin is required for the interface (Figure 11).

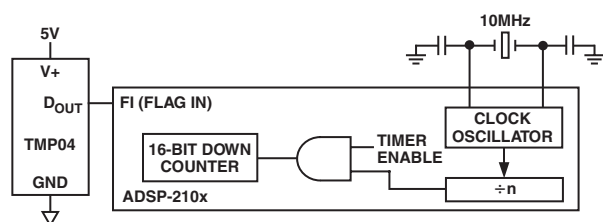

Figure 11. Interfacing the TMP04 to the ADSP-210x Digital Signal Processor

The ADSP2101 only has one counter, so the interface software differs somewhat from the 80C51 example. The lack of two counters is not a limitation, however, because the DSP architecture provides very high execution speed. The ADSP-2101 executes one instruction for each clock cycle, versus one instruction for twelve clock cycles in the 80C51, so the ADSP-2101 actually produces a more accurate conversion while using a lower oscillator frequency.

The timer of the ADSP2101 is implemented as a down counter. When enabled by means of a software instruction, the counter is decremented at the clock rate divided by a programmable prescaler. Loading the value $n - 1$ into the prescaler register will divide the crystal oscillator frequency by n . For the circuit of

Figure 11, therefore, loading 4 into the prescaler will divide the 10 MHz crystal oscillator by 5 and thereby decrement the counter at a 2 MHz rate. The TMP04 output is ratiometric, of course, so the exact clock frequency is not important.

A typical software routine for interfacing the TMP04 to the ADSP2101 is shown in Listing 2. The program begins by initializing the prescaler and loading the counter with 0FFFF_{H} . The ADSP2101 monitors the FI flag input to establish the falling edge of the TMP04 output, and starts the counter. When the TMP04 output goes high, the counter is stopped. The counter value is then subtracted from 0FFFF_{H} to obtain the actual number of counts, and the count is saved. Then the counter is reloaded and runs until the TMP04 output goes low. Finally, the TMP04 pulsewidths are converted to temperature using the scale factor of Equation 1.

Some applications may require a hardware interface for the TMP04. One such application could be to monitor the temperature of a high power microprocessor. The TMP04 interface would be included as part of the system ASIC, so that the microprocessor would not be burdened with the overhead of timing the output pulsewidths.

A typical hardware interface for the TMP04 is shown in Figure 12. The circuit measures the output pulsewidths with a resolution of $\pm 1 \mu\text{s}$. The TMP04 T1 and T2 periods are measured with two cascaded 74HC4520 8-bit counters. The counters, accumulating clock pulses from the 1 MHz external oscillator, have a maximum period of 65 ms.

The logic interface is straightforward. On both the rising and falling edges of the TMP04 output, an exclusive-or gate generates a pulse. This pulse triggers one half of a 74HC4538 dual one-shot. The pulse from the one-shot is ANDed with the TMP04 output polarity to store the counter contents in the appropriate output registers. The falling edge of this pulse also triggers the second one-shot, which generates a reset pulse for the counters. After the reset pulse, the counters will begin to count the next TMP04 output phase.

As previously mentioned, the counters have a maximum period of 65 ms with a 1 MHz clock input. However, the TMP04's T1 and T2 times will never exceed 32 ms. Therefore, the most significant bit (MSB) of counter #2 will not go high in normal operation, and can be used to warn the system that an error condition (such as a broken connection to the TMP04) exists.

The circuit of Figure 12 will latch and save both the T1 and T2 times simultaneously. This makes the circuit suitable for debugging or test purposes as well as for a general purpose hardware interface. In a typical ASIC application, of course, one set of latches could be eliminated if the latch contents, and the output polarity, were read before the next phase reversal of the TMP04.

TMP03/TMP04

Listing 2. Software Routine for the TMP04-to-ADSP-210x Interface

```
;
{ ADSP-21XX Temperature Measurement Routine          TEMPERAT.DSP

    Altered Registers:      ax0, ay0, af, ar,
                           si, sr0,
                           my0, mr0, mr1, mr2.

    Return value:          ar -> temperature result in 14.2 format
    Computation time:     2 * TMP04 output period
}
.MODULE/RAM/BOOT=0      TEMPERAT;                { Beginning TEMPERAT Program }
.ENTRY TEMPMEAS;        { Entry point of this subroutine }
.CONST PRESCALER=4;
.CONST TIMFULSCALE=0Xffff;
TEMPMEAS:      si=PRESCALER;                      { For timer prescaler }
               sr0=TIMFULSCALE;                  { Timer counter full scale }
               dm(0x3FFB)=si;                    { Timer Prescaler set up to 5 }
               si=TIMFULSCALE;                  { CLKin=10MHz, Timer Period=32.768ms }
               dm(0x3FFC)=si;                    { Timer Counter Register to 65535 }
               dm(0x3FFD)=si;                    { Timer Period Register to 65535 }
               imask=0x01;                       { Unmask Interrupt timer }
TEST1:         if not fi jump TEST1;              { Check for FI=1 }
TEST0:         if fi jump TEST0;                  { Check for FI=0 to locate transition }
               ena timer;                        { Enable timer, count at a 500ns rate }
COUNT2:      if not fi jump COUNT2;              { Check for FI=1 to stop count }
               dis timer;
               ay0=dm(0x3FFC);                    { Save counter=T2 in ALU register }
               ar=sr0-ay0;
               ax0=ar;
               dm(0x3FFC)=si;                    { Reload counter at full scale }
               ena timer;
COUNT1:      if fi jump COUNT1;                  { Check for FI=0 to stop count }
               dis timer;
               ay0=dm(0x3FFC);                    { Save counter=T1 in ALU register }
               ar=sr0-ay0;
               my0=400;
               mr=ar*my0(uu);                     { mr=400*T1 }
               ay0=mr0;                          { af=MSW of dividend, ay0=LSW }
               ar=mr1; af=pass ar;                { ax0=16-bit divisor }
               astat=0;                          { To clear AQ flag }
               divq ax0; divq ax0;                { Division 400*T1/T2 }
               divq ax0; divq ax0;                { with 0.3 < T1/T2 < 0.7 }
               divq ax0; divq ax0;
               divq ax0; divq ax0;
               divq ax0; divq ax0;
               divq ax0; divq ax0;
               divq ax0; divq ax0;
               divq ax0; divq ax0;
               divq ax0; divq ax0;
               divq ax0; divq ax0;
               ax0=0x03AC;                        { Result in ay0 }
               ar=ax0-ay0;                        { ax0=235*4 }
               rts;                               { ar=235-400*T1/T2, result in 0C }
               { format 14.2 }
.ENDMOD;                                          { End of the subprogram }
```

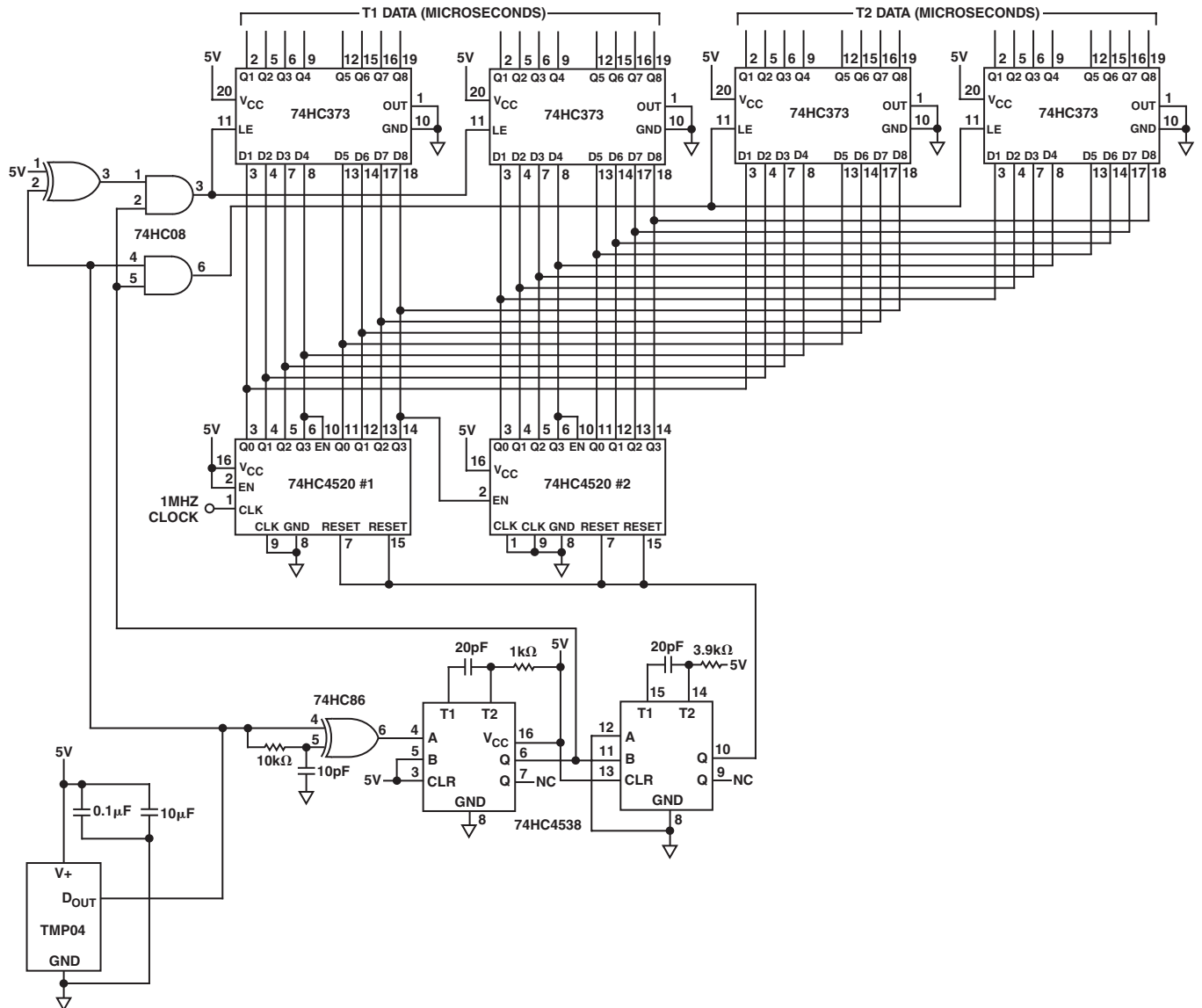

Figure 12. A Hardware Interface for the TMP04

Monitoring Electronic Equipment

The TMP03 are ideal for monitoring the thermal environment within electronic equipment. For example, the surface-mounted package will accurately reflect the exact thermal conditions which affect nearby integrated circuits. The TO-92 package, on the other hand, can be mounted above the surface of the board, to measure the temperature of the air flowing over the board.

The TMP03 and TMP04 measure and convert the temperature at the surface of their own semiconductor chip. When the TMP03 are used to measure the temperature of a nearby heat source, the thermal impedance between the heat source and the TMP03 must be considered. Often, a thermocouple or other temperature sensor is used to measure the temperature of the source

while the TMP03 temperature is monitored by measuring T1 and T2. Once the thermal impedance is determined, the temperature of the heat source can be inferred from the TMP03 output.

One example of using the TMP04 to monitor a high power dissipation microprocessor or other IC is shown in Figure 13. The TMP04, in a surface mount package, is mounted directly beneath the microprocessor's pin grid array (PGA) package. In a typical application, the TMP04's output would be connected to an ASIC where the pulsewidth would be measured (see the Hardware Interface section of this data sheet for a typical interface schematic). The TMP04 pulse output provides a significant

TMP03/TMP04

advantage in this application because it produces a linear temperature output while needing only one I/O pin and without requiring an A/D converter.

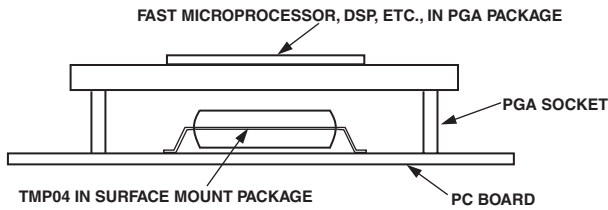
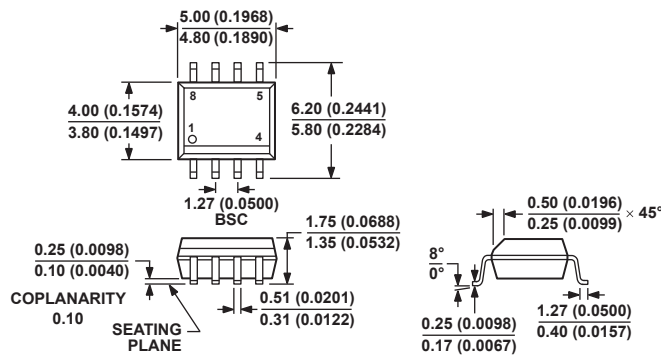

Figure 13. Monitoring the Temperature of a High Power Microprocessor Improves System Reliability

Thermal Response Time

The time required for a temperature sensor to settle to a specified accuracy is a function of the thermal mass of, and the thermal conductivity between, the sensor and the object being sensed. Thermal mass is often considered equivalent to capacitance. Thermal conductivity is commonly specified using the symbol Θ , and can be thought of as thermal resistance. It is commonly specified in units of degrees per watt of power transferred across the thermal joint. Thus, the time required for the TMP03 to settle to the desired accuracy is dependent on the package selected, the thermal contact established in that particular application, and the equivalent power of the heat source. In most applications, the settling time is probably best determined empirically. The TMP03 output operates at a nominal frequency of 35 Hz at 25°C, so the minimum settling time resolution is 27 ms.

OUTLINE DIMENSIONS



COMPLIANT TO JEDEC STANDARDS MS-012-AA
CONTROLLING DIMENSIONS ARE IN MILLIMETERS; INCH DIMENSIONS (IN PARENTHESES) ARE ROUNDED-OFF MILLIMETER EQUIVALENTS FOR REFERENCE ONLY AND ARE NOT APPROPRIATE FOR USE IN DESIGN.

8-Lead Standard Small Outline Package [SOIC_N]
Narrow Body
(R-8)

Dimensions shown in millimeters and (inches)

012407-A

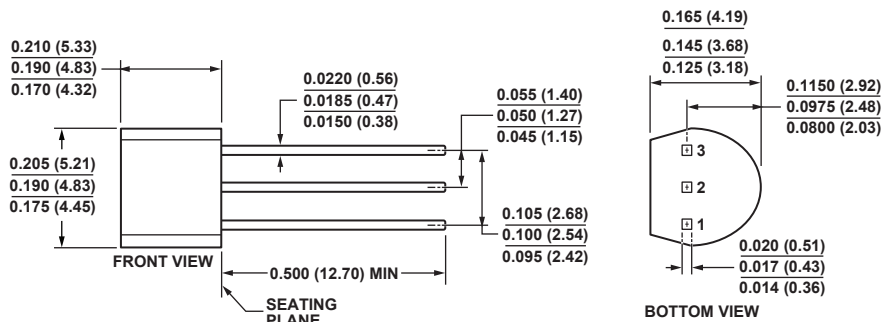

COMPLIANT TO JEDEC STANDARDS TO-226-AA
CONTROLLING DIMENSIONS ARE IN INCHES; MILLIMETER DIMENSIONS (IN PARENTHESES) ARE ROUNDED-OFF EQUIVALENTS FOR REFERENCE ONLY AND ARE NOT APPROPRIATE FOR USE IN DESIGN.

3-Pin Plastic Header-Style Package [TO-92]
(T-3-1)

Dimensions shown in inches and (millimeters)

042208-A

REVISION HISTORY

9/2016—Rev. A to Rev. B

Deleted 8-Pin TSSOP Package Universal
Changes to Absolute Maximum Ratings Section and
Ordering Guide3
Updated Outline Dimensions.....16