

# MAC4DCM, MAC4DCN

Preferred Device

## Triacs

### Silicon Bidirectional Thyristors

Designed for high volume, low cost, industrial and consumer applications such as motor control; process control; temperature, light and speed control.

#### Features

- Small Size Surface Mount DPAK Package
- Passivated Die for Reliability and Uniformity
- Blocking Voltage to 800 V
- On-State Current Rating of 4.0 A RMS at 108°C
- High Immunity to dv/dt – 500 V/μs at 125°C
- High Immunity to di/dt – 6.0 A/ms at 125°C
- Epoxy Meets UL 94 V-0 @ 0.125 in
- ESD Ratings: Human Body Model, 3B > 8000 V  
Machine Model, C > 400 V
- Pb-Free Packages are Available

#### MAXIMUM RATINGS (T<sub>J</sub> = 25°C unless otherwise noted)

Rating	Symbol	Value	Unit
Peak Repetitive Off-State Voltage (Note 1) (T <sub>J</sub> = -40 to 125°C, Sine Wave, 50 to 60 Hz, Gate Open)	V <sub>DRM</sub> , V <sub>RRM</sub>	600 800	V
On-State RMS Current (Full Cycle Sine Wave, 60 Hz, T <sub>C</sub> = 108°C)	I <sub>T(RMS)</sub>	4.0	A
Peak Non-Repetitive Surge Current (One Full Cycle Sine Wave, 60 Hz, T <sub>J</sub> = 125°C)	I <sub>TSM</sub>	40	A
Circuit Fusing Consideration (t = 8.3 msec)	I <sup>2</sup> t	6.6	A <sup>2</sup> sec
Peak Gate Power (Pulse Width ≤ 10 μsec, T <sub>C</sub> = 108°C)	P <sub>GM</sub>	2.0	W
Average Gate Power (t = 8.3 msec, T <sub>C</sub> = 108°C)	P <sub>G(AV)</sub>	1.0	W
Peak Gate Current (Pulse Width ≤ 20 μsec, T <sub>C</sub> = 108°C)	I <sub>GM</sub>	4.0	A
Peak Gate Voltage (Pulse Width ≤ 20 μsec, T <sub>C</sub> = 108°C)	V <sub>GM</sub>	5.0	V
Operating Junction Temperature Range	T <sub>J</sub>	-40 to 125	°C
Storage Temperature Range	T <sub>stg</sub>	-40 to 150	°C

Stresses exceeding Maximum Ratings may damage the device. Maximum Ratings are stress ratings only. Functional operation above the Recommended Operating Conditions is not implied. Extended exposure to stresses above the Recommended Operating Conditions may affect device reliability.

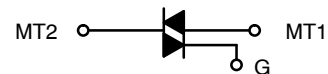
1. V<sub>DRM</sub> and V<sub>RRM</sub> for all types can be applied on a continuous basis. Blocking voltages shall not be tested with a constant current source such that the voltage ratings of the device are exceeded.



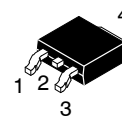
Expertise Applied | Answers Delivered

Littelfuse.com

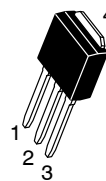
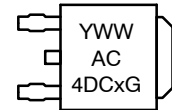
### TRIACS 4.0 AMPERES RMS 600 – 800 VOLTS



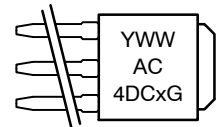
#### MARKING DIAGRAMS



DPAK  
CASE 369C  
STYLE 6



DPAK-3  
CASE 369D  
STYLE 6



Y = Year  
WW = Work Week  
AC4DCx = Device Code  
x = M or N  
G = Pb-Free Package

#### PIN ASSIGNMENT

1	Main Terminal 1
2	Main Terminal 2
3	Gate
4	Main Terminal 2

#### ORDERING INFORMATION

See detailed ordering and shipping information in the package dimensions section on page 2 of this data sheet.

Preferred devices are recommended choices for future use and best overall value.

# MAC4DCM, MAC4DCN

## THERMAL CHARACTERISTICS

Characteristic	Symbol	Max	Unit
Thermal Resistance, – Junction-to-Case – Junction-to-Ambient – Junction-to-Ambient (Note 2)	$R_{\theta JC}$ $R_{\theta JA}$ $R_{\theta JA}$	3.5 88 80	°C/W
Maximum Lead Temperature for Soldering Purposes (Note 3)	$T_L$	260	°C

## ELECTRICAL CHARACTERISTICS ( $T_J = 25^\circ\text{C}$ unless otherwise noted; Electricals apply in both directions)

Characteristic	Symbol	Min	Typ	Max	Unit
----------------	--------	-----	-----	-----	------

## OFF CHARACTERISTICS

Peak Repetitive Blocking Current ( $V_D = \text{Rated } V_{DRM}, V_{RRM}; \text{ Gate Open}$ ) $T_J = 25^\circ\text{C}$ $T_J = 125^\circ\text{C}$	$I_{DRM}$ , $I_{RRM}$	– –	– –	0.01 2.0	mA
--	--------------------------	--------	--------	-------------	----

## ON CHARACTERISTICS

Peak On-State Voltage (Note 4) ( $I_{TM} = \pm 6.0 \text{ A}$ )	$V_{TM}$	–	1.3	1.6	V
Gate Trigger Current (Continuous dc) ( $V_D = 12 \text{ V}, R_L = 100 \Omega$ ) MT2(+), G(+) MT2(+), G(–) MT2(–), G(–)	$I_{GT}$	8.0 8.0 8.0	12 18 22	35 35 35	mA
Gate Trigger Voltage (Continuous dc) ( $V_D = 12 \text{ V}, R_L = 100 \Omega$ ) MT2(+), G(+) MT2(+), G(–) MT2(–), G(–)	$V_{GT}$	0.5 0.5 0.5	0.8 0.8 0.8	1.3 1.3 1.3	V
Gate Non-Trigger Voltage (Continuous dc) ( $V_D = 12 \text{ V}, R_L = 100 \Omega$ ) MT2(+), G(+); MT2(+), G(–); MT2(–), G(–) $T_J = 125^\circ\text{C}$	$V_{GD}$	0.2	0.4	–	V
Holding Current ( $V_D = 12 \text{ V}, \text{ Gate Open}, \text{ Initiating Current} = \pm 200 \text{ mA}$ )	$I_H$	6.0	22	35	mA
Latching Current ( $V_D = 12 \text{ V}, I_G = 35 \text{ mA}$ ) MT2(+), G(+) MT2(+), G(–) MT2(–), G(–)	$I_L$	– – –	30 50 20	60 80 60	mA

## DYNAMIC CHARACTERISTICS

Rate of Change of Commutating Current ( $V_D = 400 \text{ V}, I_{TM} = 4.0 \text{ A}, \text{ Commutating } dv/dt = 18 \text{ V}/\mu\text{sec},$ Gate Open, $T_J = 125^\circ\text{C}, f = 250 \text{ Hz}, CL = 5.0 \mu\text{F}, LL = 20 \text{ mH}, \text{ No Snubber}$ ) (See Figure 16)	$di/dt(c)$	6.0	8.4	–	A/ms
Critical Rate of Rise of Off-State Voltage ( $V_D = 0.67 \times \text{Rated } V_{DRM}, \text{ Exponential Waveform}, \text{ Gate Open}, T_J = 125^\circ\text{C}$ )	$dv/dt$	500	1700	–	V/ $\mu\text{s}$

2. These ratings are applicable when surface mounted on the minimum pad sizes recommended.
3. 1/8" from case for 10 seconds.
4. Pulse Test: Pulse Width  $\leq 2.0 \text{ msec}$ , Duty Cycle  $\leq 2\%$ .

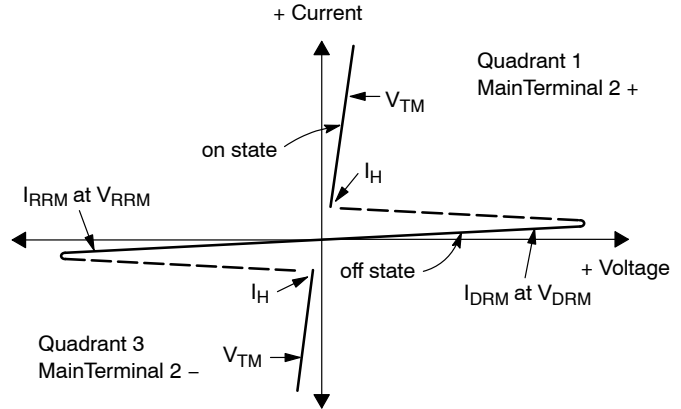
## ORDERING INFORMATION

Device	Package Type	Package	Shipping
MAC4DCM-001	DPAK-3	369D	75 Units / Rail
MAC4DCM-1G	DPAK-3 (Pb-Free)	369D	75 Units / Rail
MAC4DCMT4	DPAK	369C	2500 / Tape & Reel
MAC4DCMT4G	DPAK (Pb-Free)	369C	2500 / Tape & Reel
MAC4DCN-001	DPAK-3	369D	75 Units / Rail
MAC4DCN-1G	DPAK-3 (Pb-Free)	369D	75 Units / Rail
MAC4DCNT4	DPAK	369C	2500 / Tape & Reel
MAC4DCNT4G	DPAK (Pb-Free)	369C	2500 / Tape & Reel

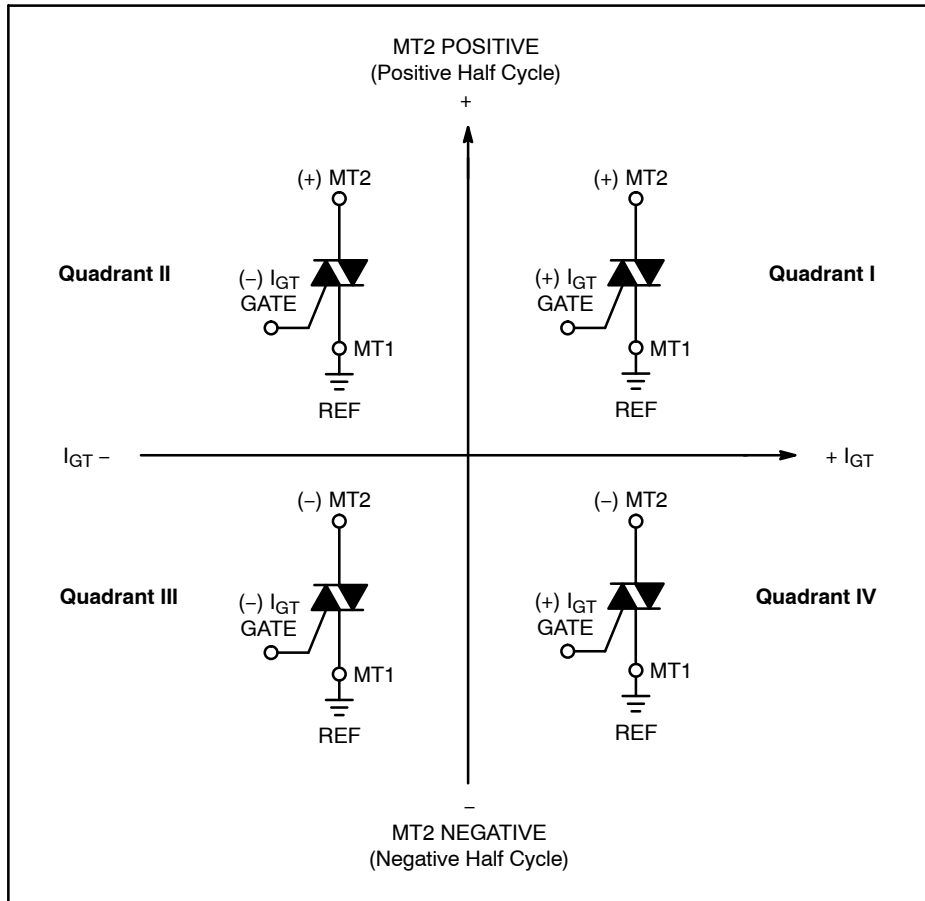
# MAC4DCM, MAC4DCN

## Voltage Current Characteristic of Triacs (Bidirectional Device)

Symbol	Parameter
$V_{DRM}$	Peak Repetitive Forward Off-State Voltage
$I_{DRM}$	Peak Forward Blocking Current
$V_{RRM}$	Peak Repetitive Reverse Off-State Voltage
$I_{RRM}$	Peak Reverse Blocking Current
$V_{TM}$	Maximum On-State Voltage
$I_H$	Holding Current



### Quadrant Definitions for a Triac



All polarities are referenced to MT1.

With in-phase signals (using standard AC lines) quadrants I and III are used.

# MAC4DCM, MAC4DCN

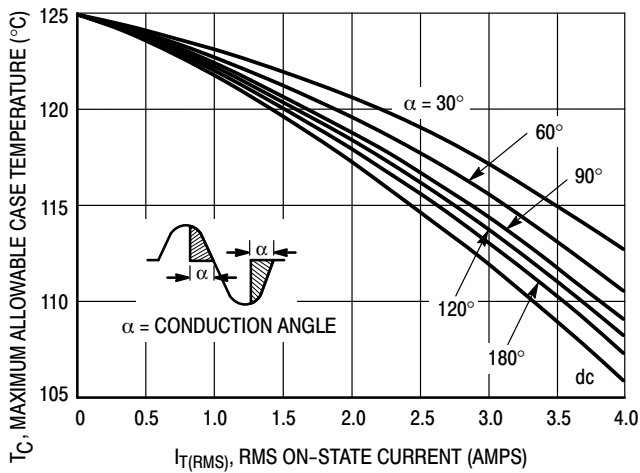


Figure 1. RMS Current Derating

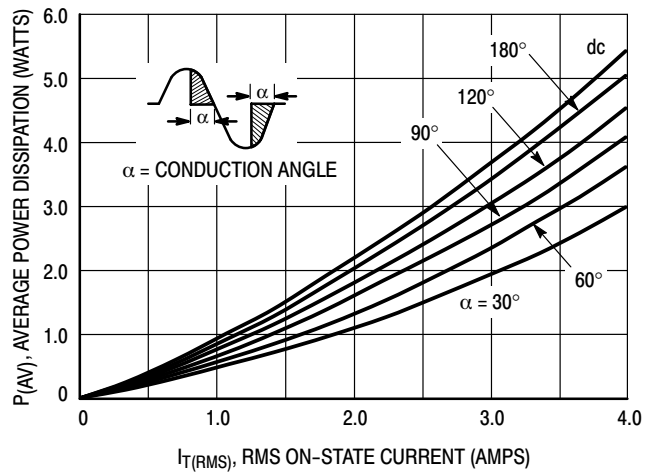


Figure 2. On-State Power Dissipation

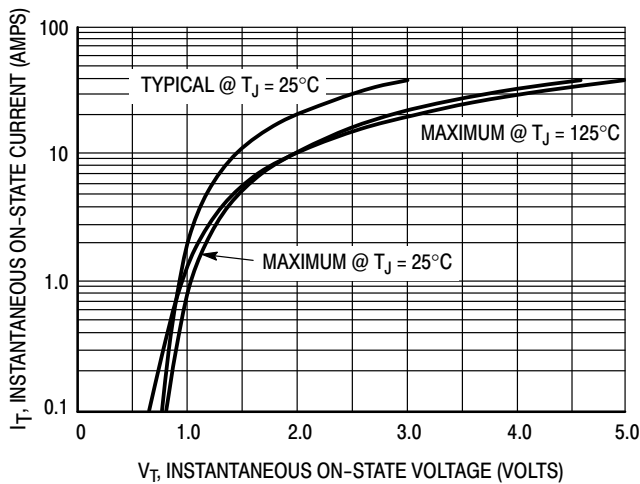


Figure 3. On-State Characteristics

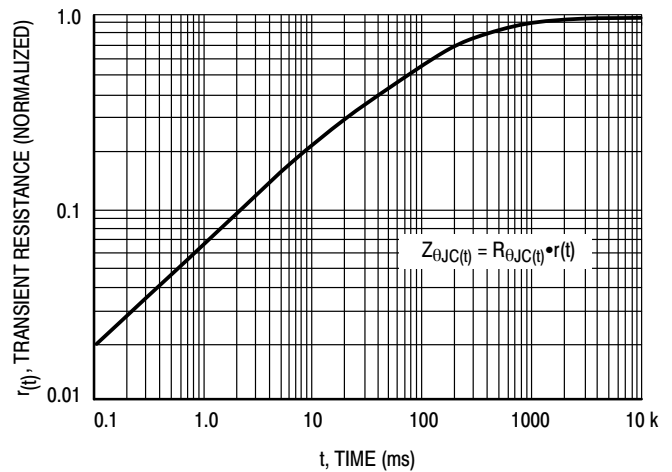


Figure 4. Transient Thermal Response

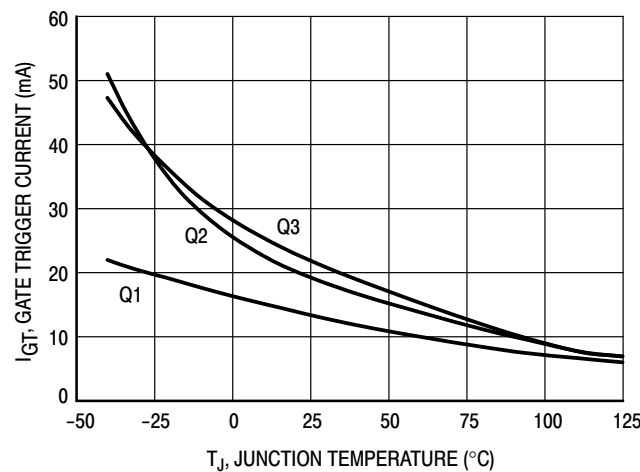


Figure 5. Typical Gate Trigger Current versus Junction Temperature

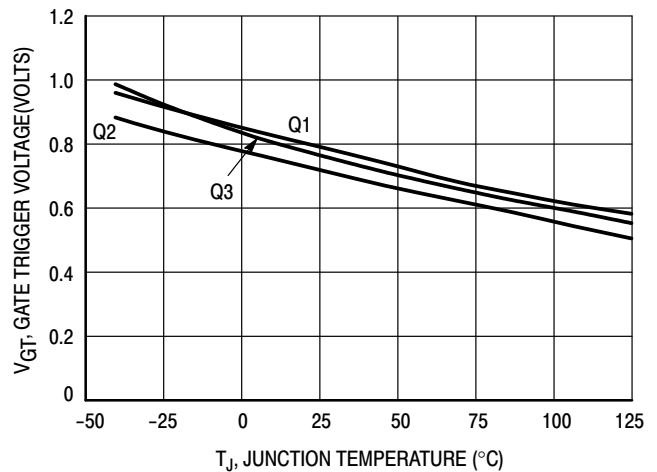
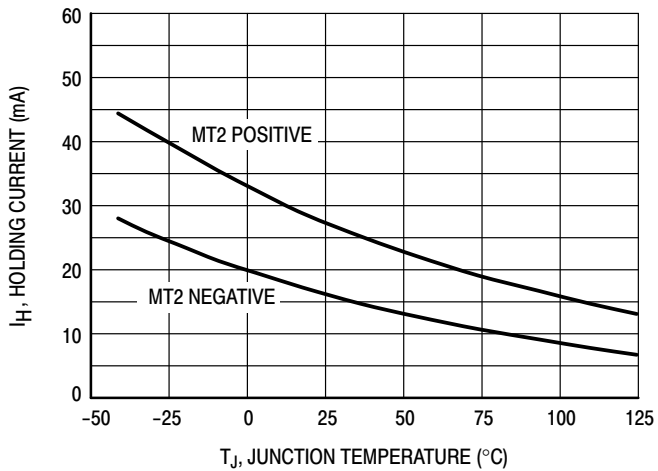
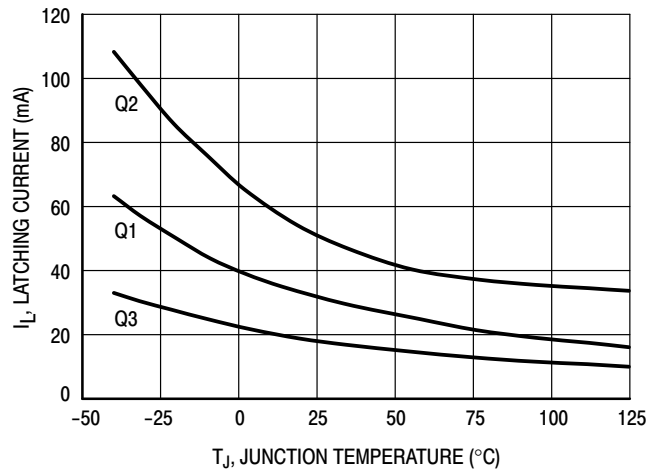


Figure 6. Typical Gate Trigger Voltage versus Junction Temperature

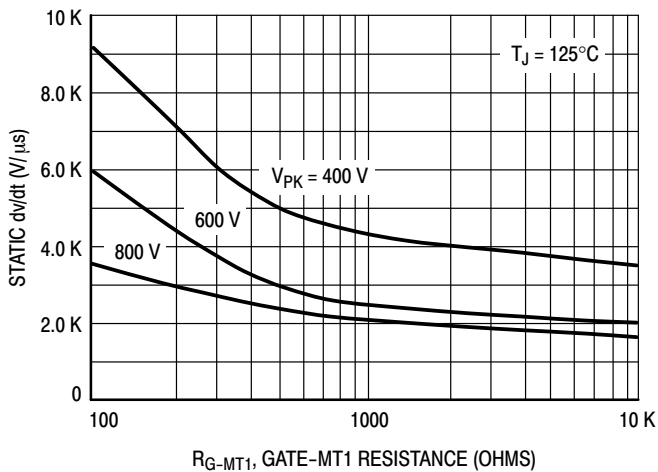
# MAC4DCM, MAC4DCN



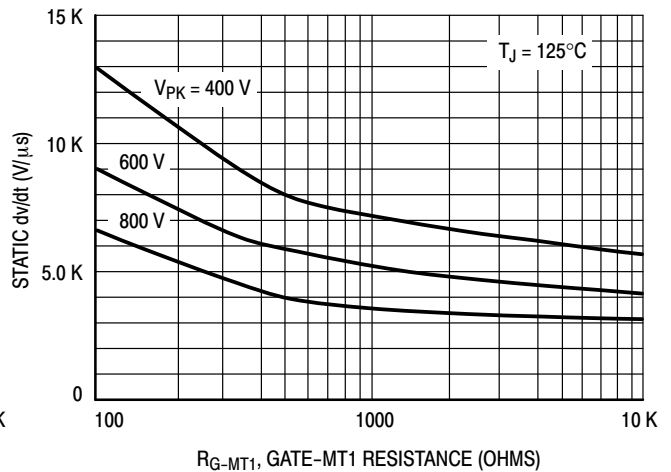
**Figure 7. Typical Holding Current versus Junction Temperature**



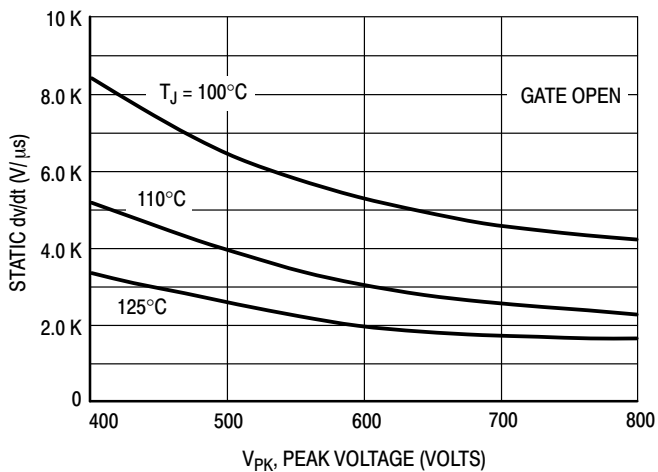
**Figure 8. Typical Latching Current versus Junction Temperature**



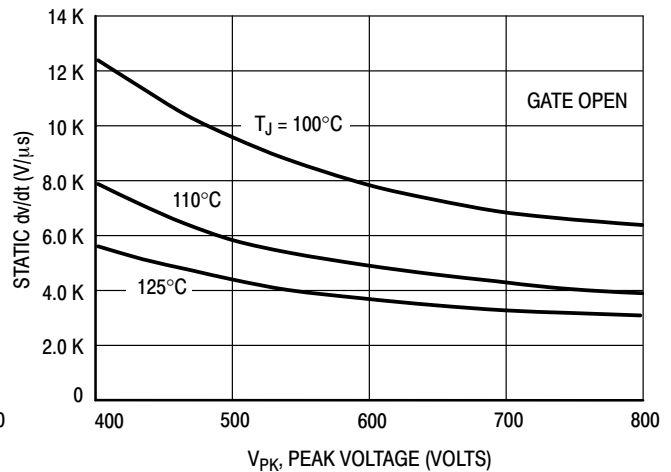
**Figure 9. Exponential Static dv/dt versus Gate-MT1 Resistance, MT2(+)**



**Figure 10. Exponential Static dv/dt versus Gate-MT1 Resistance, MT2(-)**

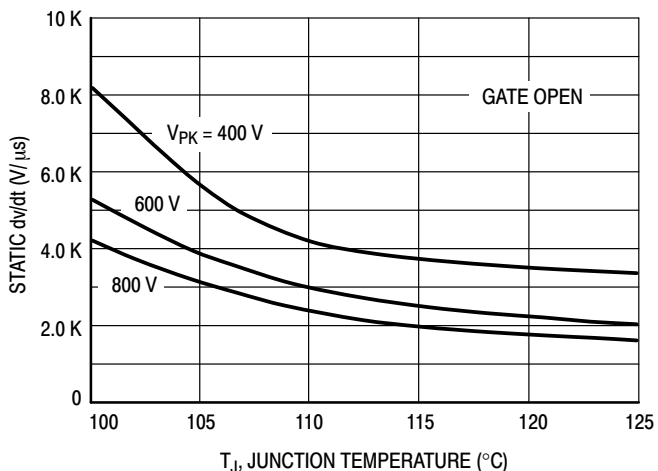


**Figure 11. Exponential Static dv/dt versus Peak Voltage, MT2(+)**

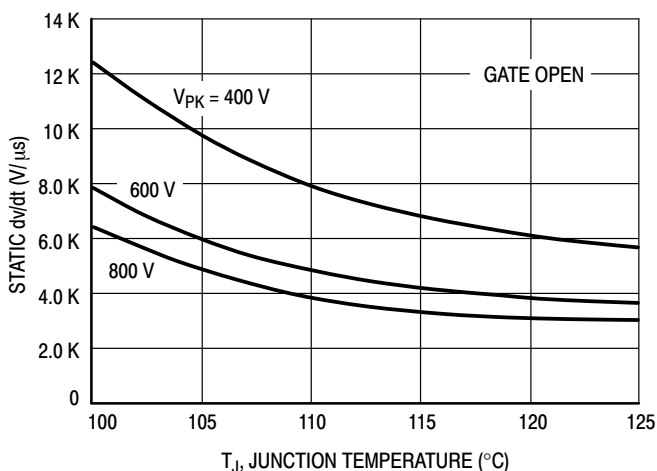


**Figure 12. Exponential Static dv/dt versus Peak Voltage, MT2(-)**

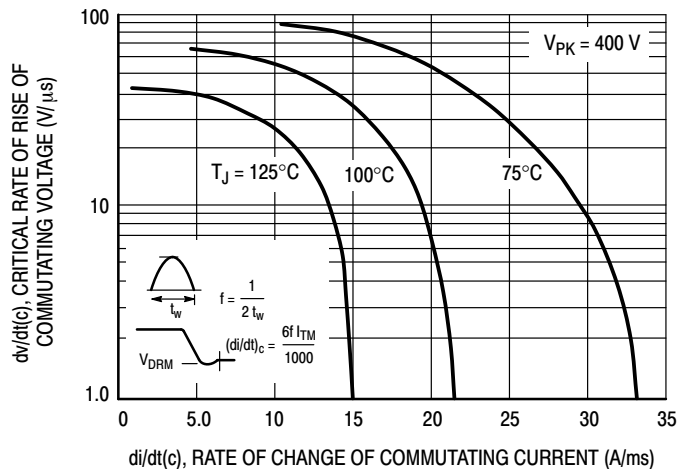
# MAC4DCM, MAC4DCN



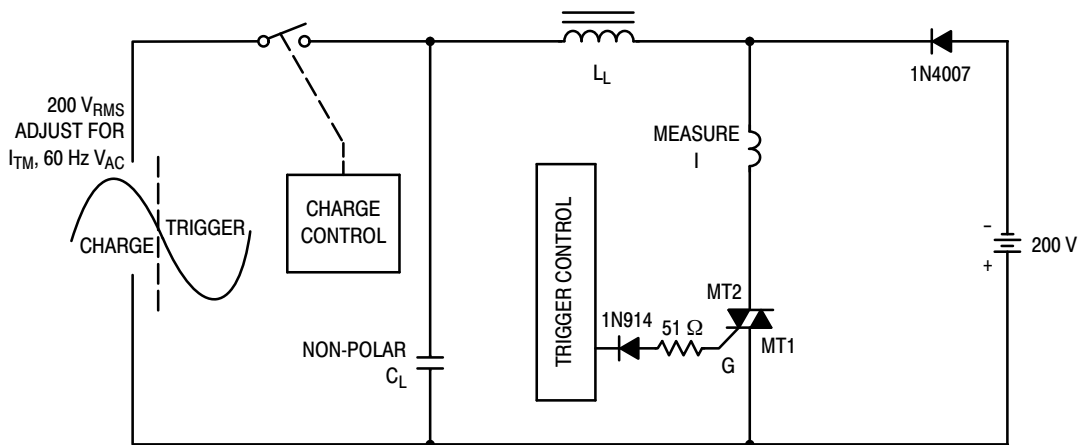
**Figure 13. Typical Exponential Static dv/dt versus Junction Temperature, MT2(+)**



**Figure 14. Typical Exponential Static dv/dt versus Junction Temperature, MT2(-)**



**Figure 15. Critical Rate of Rise of Commutating Voltage**



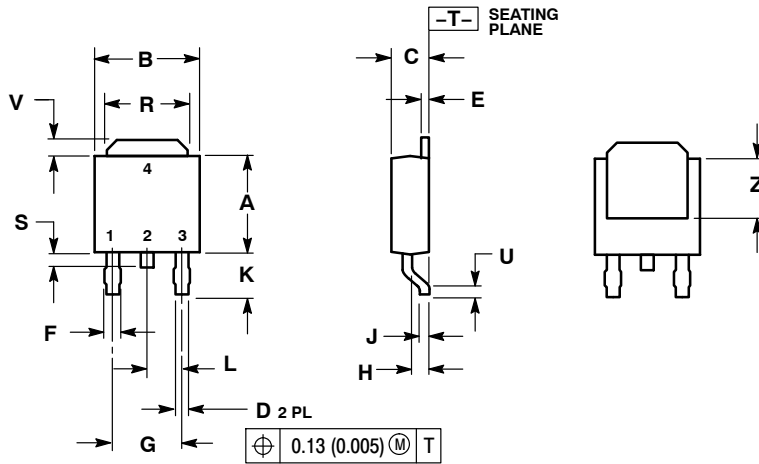
Note: Component values are for verification of rated  $(di/dt)_c$ . See AN1048 for additional information.

**Figure 16. Simplified Test Circuit to Measure the Critical Rate of Rise of Commutating Current  $(di/dt)_c$**

# MAC4DCM, MAC4DCN

## PACKAGE DIMENSIONS

DPAK  
CASE 369C  
ISSUE O

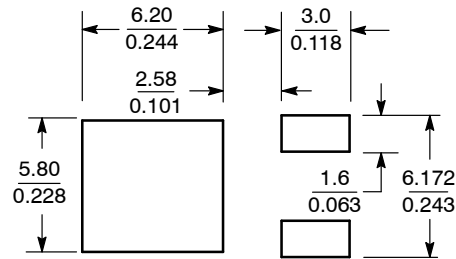


- NOTES:  
1. DIMENSIONING AND TOLERANCING PER ANSI Y14.5M, 1982.  
2. CONTROLLING DIMENSION: INCH.

DIM	INCHES		MILLIMETERS	
	MIN	MAX	MIN	MAX
A	0.235	0.245	5.97	6.22
B	0.250	0.265	6.35	6.73
C	0.086	0.094	2.19	2.38
D	0.027	0.035	0.69	0.88
E	0.018	0.023	0.46	0.58
F	0.037	0.045	0.94	1.14
G	0.180 BSC		4.58 BSC	
H	0.034	0.040	0.87	1.01
J	0.018	0.023	0.46	0.58
K	0.102	0.114	2.60	2.89
L	0.090 BSC		2.29 BSC	
R	0.180	0.215	4.57	5.45
S	0.025	0.040	0.63	1.01
U	0.020	---	0.51	---
V	0.035	0.050	0.89	1.27
Z	0.155	---	3.93	---

STYLE 6:  
PIN 1. MT1  
2. MT2  
3. GATE  
4. MT2

### SOLDERING FOOTPRINT

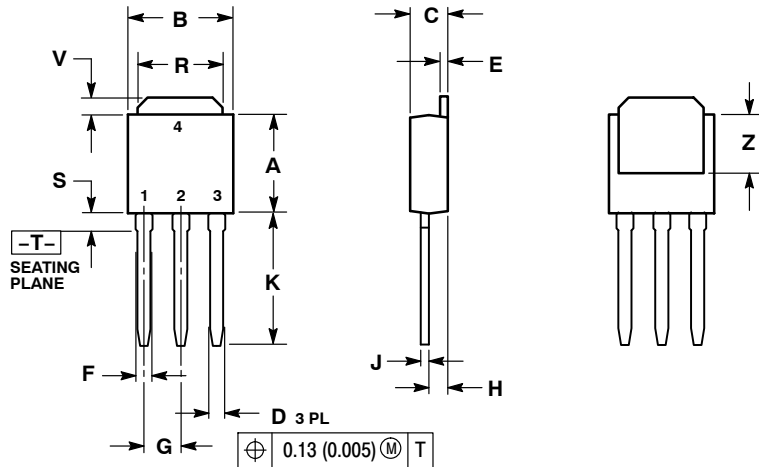


SCALE 3:1 (mm/inches)

# MAC4DCM, MAC4DCN

## PACKAGE DIMENSIONS

DPAK-3  
CASE 369D-01  
ISSUE B



**NOTES:**

1. DIMENSIONING AND TOLERANCING PER ANSI Y14.5M, 1982.
2. CONTROLLING DIMENSION: INCH.

DIM	INCHES		MILLIMETERS	
	MIN	MAX	MIN	MAX
A	0.235	0.245	5.97	6.35
B	0.250	0.265	6.35	6.73
C	0.086	0.094	2.19	2.38
D	0.027	0.035	0.69	0.88
E	0.018	0.023	0.46	0.58
F	0.037	0.045	0.94	1.14
G	0.090	BSC	2.29	BSC
H	0.034	0.040	0.87	1.01
J	0.018	0.023	0.46	0.58
K	0.350	0.380	8.89	9.65
R	0.180	0.215	4.45	5.45
S	0.025	0.040	0.63	1.01
V	0.035	0.050	0.89	1.27
Z	0.155	---	3.93	---

**STYLE 6:**

- PIN 1. MT1
- 2. MT2
- 3. GATE
- 4. MT2

Littelfuse products are not designed for, and shall not be used for, any purpose (including, without limitation, automotive, military, aerospace, medical, life-saving, life-sustaining or nuclear facility applications, devices intended for surgical implant into the body, or any other application in which the failure or lack of desired operation of the product may result in personal injury, death, or property damage) other than those expressly set forth in applicable Littelfuse product documentation. Warranties granted by Littelfuse shall be deemed void for products used for any purpose not expressly set forth in applicable Littelfuse documentation. Littelfuse shall not be liable for any claims or damages arising out of products used in applications not expressly intended by Littelfuse as set forth in applicable Littelfuse documentation. The sale and use of Littelfuse products is subject to Littelfuse Terms and Conditions of Sale, unless otherwise agreed by Littelfuse.

Littelfuse.com