

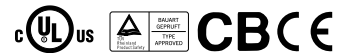

■ Features :

- Universal AC input/Full range
- Protections: Short circuit / Overload / Over voltage
- Cooling by free air convection
- Can be installed on DIN rail TS-35/7.5 or 15
- NEC class 2 / LPS compliant
- Built in DC OK active signal
- LED indicator for power on
- No load power consumption<0.75W
- 100% full load burn-in test
- 3 years warranty



SPECIFICATION

| MODEL | MDR-20-5 | MDR-20-12 | MDR-20-15 | MDR-20-24 | |
|-----------------------|---|---|----------------------------------|---------------------|-----------------|
| OUTPUT | DC VOLTAGE | 5V | 12V | 15V | 24V |
| | RATED CURRENT | 3A | 1.67A | 1.34A | 1A |
| | CURRENT RANGE | 0 ~ 3A | 0 ~ 1.67A | 0 ~ 1.34A | 0 ~ 1A |
| | RATED POWER | 15W | 20W | 20W | 24W |
| | RIPPLE & NOISE (max.) Note.2 | 80mVp-p | 120mVp-p | 120mVp-p | 150mVp-p |
| | VOLTAGE ADJ. RANGE | 4.75 ~ 5.5V | 10.8 ~ 13.2V | 13.5 ~ 16.5V | 21.6 ~ 26.4V |
| | VOLTAGE TOLERANCE Note.3 | ±2.0% | ±1.0% | ±1.0% | ±1.0% |
| | LINE REGULATION | ±1.0% | ±1.0% | ±1.0% | ±1.0% |
| | LOAD REGULATION | ±1.0% | ±1.0% | ±1.0% | ±1.0% |
| | SETUP, RISE TIME Note.5 | 500ms, 30ms/230VAC | 1000ms, 30ms/115VAC at full load | | |
| HOLD UP TIME (Typ.) | 50ms/230VAC | 20ms/115VAC at full load | | | |
| INPUT | VOLTAGE RANGE | 85 ~ 264VAC (accepts 120 ~ 370VDC but not certified) | | | |
| | FREQUENCY RANGE | 47 ~ 63Hz | | | |
| | EFFICIENCY (Typ.) | 76% | 80% | 81% | 84% |
| | AC CURRENT (Typ.) | 0.55A/115VAC 0.35A/230VAC | | | |
| | INRUSH CURRENT (Typ.) | COLD START 20A/115VAC | | 40A/230VAC | |
| | LEAKAGE CURRENT | <1mA/ 240VAC | | | |
| PROTECTION | OVERLOAD | 105 ~ 160% rated output power Protection type : Constant current limiting, recovers automatically after fault condition is removed | | | |
| | OVER VOLTAGE | 5.75 ~ 6.75V | 13.8 ~ 16.2V | 17.25 ~ 20.25V | 27.6 ~ 32.4V |
| | | Protection type : Shut down o/p voltage, re-power on to recover | | | |
| FUNCTION | DC OK ACTIVE SIGNAL (max.) | 3.75 ~ 6V / 50mA | 9 ~ 13.5V / 40mA | 11.5 ~ 16.5V / 40mA | 18 ~ 27V / 20mA |
| ENVIRONMENT | WORKING TEMP. | -20 ~ +70°C (Refer to output load derating curve) | | | |
| | WORKING HUMIDITY | 20 ~ 90% RH non-condensing | | | |
| | STORAGE TEMP., HUMIDITY | -40 ~ +85°C, 10 ~ 95% RH | | | |
| | TEMP. COEFFICIENT | ±0.03%/°C (0 ~ 50°C) | | | |
| | VIBRATION | Component:10 ~ 500Hz, 2G 10min./1cycle, 60min. each along X, Y, Z axes; Mounting: Compliance to IEC60068-2-6 | | | |
| SAFETY & EMC (Note 4) | SAFETY STANDARDS | UL508, TUV EN60950-1 approved, NEC class 2 / LPS compliant | | | |
| | WITHSTAND VOLTAGE | I/P-O/P:3KVAC I/P-FG:1.5KVAC O/P-FG:0.5KVAC | | | |
| | ISOLATION RESISTANCE | I/P-O/P, I/P-FG, O/P-FG:100M Ohms/500VDC | | | |
| | EMI CONDUCTION & RADIATION | Compliance to EN55011,EN55022 (CISPR22), EN61204-3 Class B | | | |
| | HARMONIC CURRENT | Compliance to EN61000-3-2,-3 | | | |
| EMS IMMUNITY | Compliance to EN61000-4-2, 3, 4, 5, 6, 8, 11, EN550204, EN55024,EN61000-6-1,EN61204-3, light industry level, criteria A | | | | |
| OTHERS | MTBF | 236.9K hrs min. MIL-HDBK-217F (25°C) | | | |
| | DIMENSION | 22.5*90*100mm (W*H*D) | | | |
| | PACKING | 0.19Kg; 72pcs/14.7Kg/0.91CUFT | | | |
| NOTE | <ol style="list-style-type: none"> 1. All parameters NOT specially mentioned are measured at 230VAC input, rated load and 25°C of ambient temperature. 2. Ripple & noise are measured at 20MHz of bandwidth by using a 12" twisted pair-wire terminated with a 0.1uf & 47uf parallel capacitor. 3. Tolerance : includes set up tolerance, line regulation and load regulation. 4. The power supply is considered a component which will be installed into a final equipment. The final equipment must be re-confirmed that it still meets EMC directives. 5. Length of set up time is measured at cold first start. Turning ON/OFF the power supply may lead to increase of the set up time. | | | | |

Mechanical Specification

Case No. 956 Unit:mm

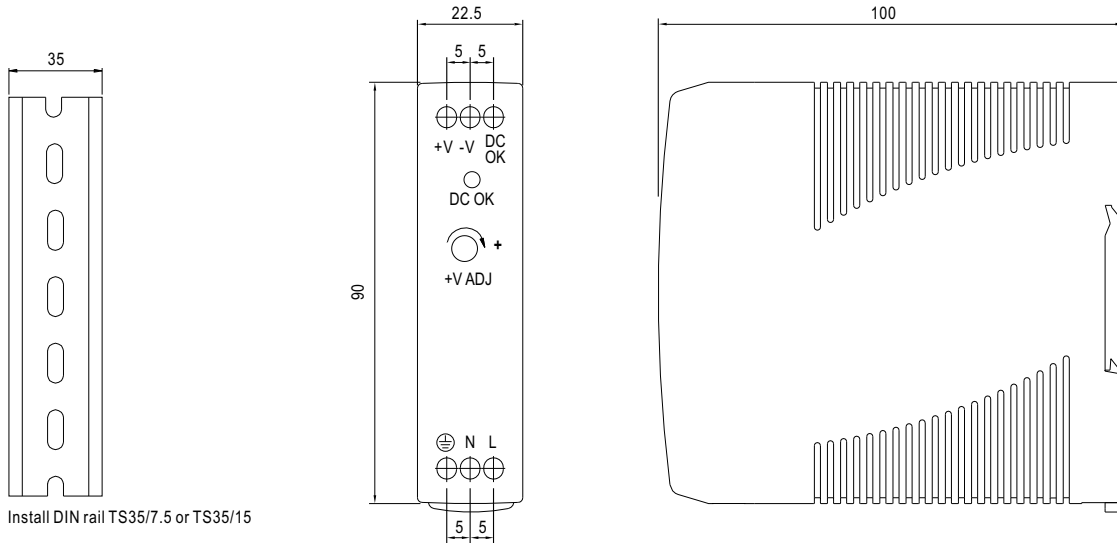

Install DIN rail TS35/7.5 or TS35/15

Block Diagram

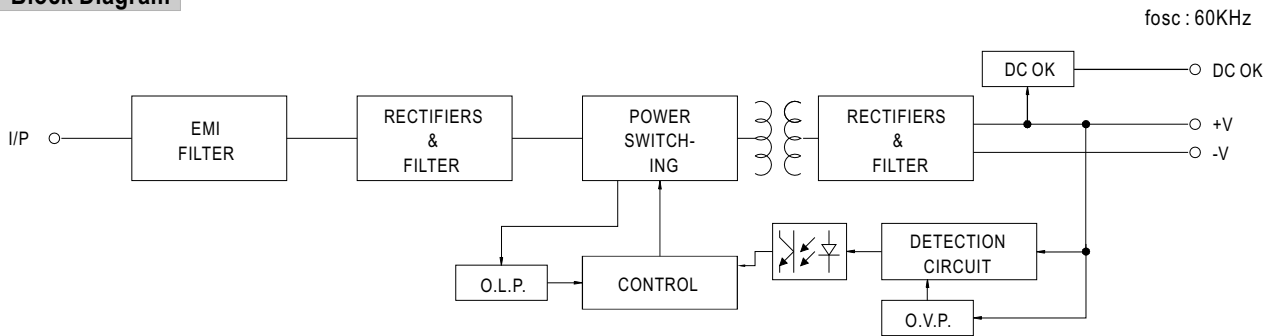

Application of DC OK Active Signal

(a) 5V signal

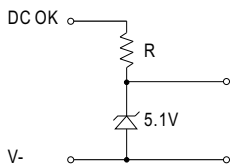

| Model | R |
|-------|-------------------|
| 5V | $\geq 200\Omega$ |
| 12V | $\geq 1.5K\Omega$ |
| 15V | $\geq 2K\Omega$ |
| 24V | $\geq 3.9K\Omega$ |

(b) LED

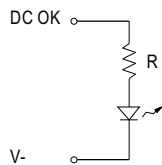

| Model | R |
|-------|-------------------|
| 5V | $\geq 1K\Omega$ |
| 12V | $\geq 2.4K\Omega$ |
| 15V | $\geq 3K\Omega$ |
| 24V | $\geq 4.7K\Omega$ |

(c) Relay

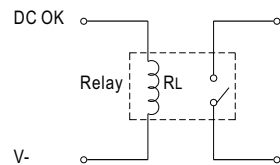

| Model | RL |
|-------|-------------------|
| 5V | $\geq 120\Omega$ |
| 12V | $\geq 700\Omega$ |
| 15V | $\geq 700\Omega$ |
| 24V | $\geq 1.2K\Omega$ |

Derating Curve

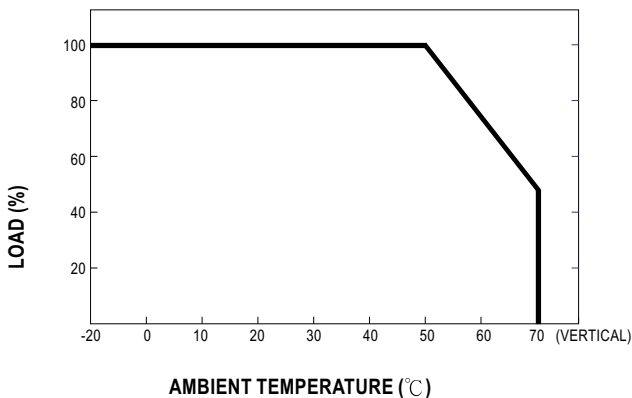

Output Derating VS Input Voltage

