

Dual 5-A High-speed, Low-side Gate Driver

Features

- Industry-standard Pin Configuration
- Automotive AEC-Q100 Grade 1 Qualified (Refer to TPM27524Q)
- 4.5-V to 23-V Single-Supply Range
- Dual Independent Channels
- 5-A Peak Source and Sink-drive Current
- Independent-enable Function for Each Output
- TTL and CMOS Compatible Threshold
- Outputs Held Low During VDD-UVLO or Input Floating
- Low Propagation Delay (14-ns Typical)
- Fast Rise-and-fall Times (7-ns and 6-ns Typical)
- <1-ns Typical Delay Matching between Two Channels
- Two Outputs Used in Parallel for Higher Drive Current
- ESD Protection Exceeds JESD 22 – 6-kV HBM, 1.5-kV CDM
- Available in SOP8, EMSOP8, DFN3X3-8, and DFN2X2-8 Packages

Applications

- Switched-mode Power Supplies
- DC-DC Converters
- Motor Control, Solar Inverters
- Gate & IGBT Drive

Description

The TPM2752x family is a series of dual-channel low-side gate drivers for MOSFET, IGBT, and GaN power switches.

High sourcing and sinking current capability of 5 A allows for improving switching efficiencies by minimizing slew time and switching loss. The device supports maximum 25-V supply voltage and -5V DC input voltage capability, which improves system robustness, especially in noisy industrial applications. Ultra-low propagation delay and excellent matching between two channels are designed for applications with tight timing requirements.

The TPM2752x family consists of a set of gate drivers with different polarities, allowing customers to select based on application needs. The wide range of package supports SOP-8, EMSOP-8, and DFN3X3-8, aligning with industrial standard packages. An extra ultra-small DFN2X2-8 assists the design of ultra-compact synchronous rectifiers in power bricks.

Typical Application Circuit

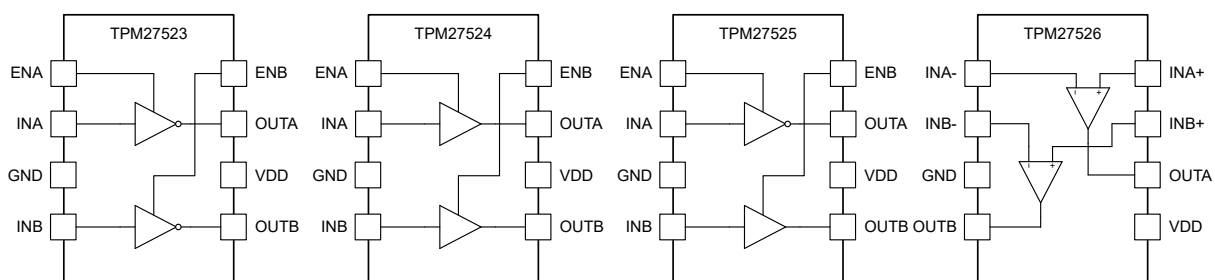
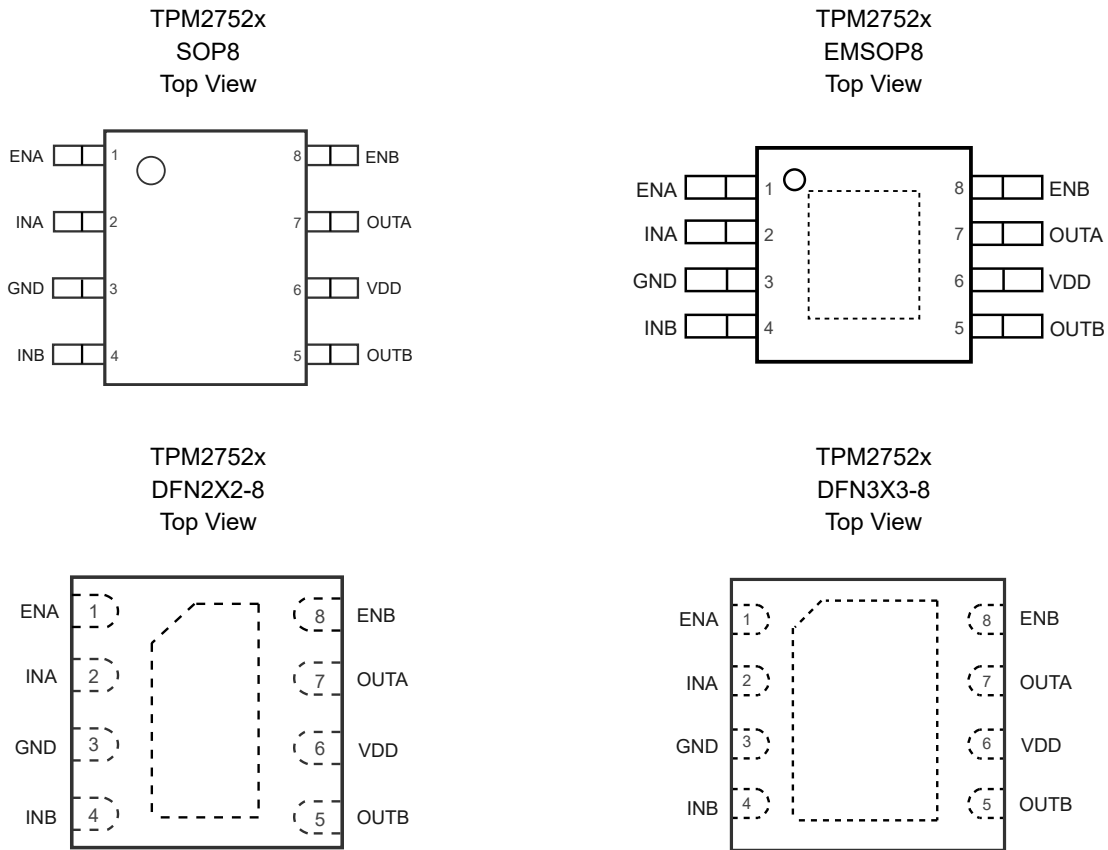

Table of Contents

Features	1
Applications	1
Description	1
Typical Application Circuit	1
Revision History	3
Pin Configuration and Functions	4
Specifications	6
Absolute Maximum Ratings ⁽¹⁾	6
ESD, Electrostatic Discharge Protection.....	6
Recommended Operating Conditions.....	6
Thermal Information.....	7
Electrical Characteristics.....	8
Typical Performance Characteristics.....	10
Detailed Description	14
Overview.....	14
Functional Block Diagram.....	14
Feature Description.....	15
Tape and Reel Information	16
Package Outline Dimensions	18
SOP8.....	18
EMSOP8.....	19
DFN2x2-8.....	20
DFN3X3-8.....	21
Order Information	23

Revision History

Date	Revision	Notes
2020-02-24	Rev A.0	Initial Release.
2020-02-24	Rev A.1	Minor Update on Input hysteresis.
2022-04-21	Rev A.2	Updated order information, automotive grade devices, electrical table rising/ falling timing and block diagrams.
2022-12-20	Rev A.3	Moved automotive TPM27524Q to a seperated datasheet.

Pin Configuration and Functions

Table 1. Pin Functions: TPM2752x

Pin	Name	I/O	Description
1	ENA	Input	Channel A enable input
8	ENB	Input	Channel B enable input
3	GND	Ground	Device ground
2	INA	Input	Logic input. TPM27523: Inverting input; TPM27524: Non-inverting input; TPM27525: Inverting input.
4	INB	Input	Logic input. TPM27523: Inverting input; TPM27524: Non-inverting input; TPM27525: Non-inverting input.
7	OUTA	Output	Channel A output
5	OUTB	Output	Channel B output
6	VDD	Power	Power supply input

Dual 5-A High-speed, Low-side Gate Driver

Table 2. Pin Functions: TPM27526

Pin	Name	I/O	Description
1	INA-	Input	Inverting input to channel A. Connect to GND to enable channel A. Output is low if input INA- is unbiased or floating.
2	INB-	Input	Inverting input to channel B. Connect to GND to enable channel B. Output is low if input INB- is unbiased or floating.
3	GND	Ground	Device Ground
4	OUTB	Output	Channel B Output
5	VDD	Power	Power supply
6	OUTA	Output	Channel A Output
7	INB+	Input	Non-inverting input to channel B. Connect to VDD to enable channel B. Output is low if input INB+ is unbiased or floating.
8	INA+	Input	Non-inverting input to channel A. Connect to VDD to enable channel A. Output is low if input INA+ is unbiased or floating.

Specifications

Absolute Maximum Ratings ⁽¹⁾

Parameter		Min	Max	Unit
	Power Supply Voltage, VDD	-0.3	25	V
	Output Voltage Range OUTA, OUTB	-0.3	VDD + 0.3	V
		-2	VDD + 0.3 (200-ns pulse)	
	Input Voltage Range INA, INB, INA+, INA-, INB+, INB-, ENA, ENB	-5	20	V
	Continuous Output Channel Current OUTA, OUTB	-300	300	mA
	Pulsed Output Channel Current OUTA, OUTB (500 ns)	-5	5	A
	Operating Junction Temperature Range	-40	150	°C
T _{STG}	Storage Temperature Range	-65	150	°C
T _L	Lead Temperature (Soldering, 10 sec)		260	°C

- (1) Stresses beyond those listed under Absolute Maximum Ratings may cause permanent damage to the device. Exposure to any Absolute Maximum Rating condition for extended periods may affect device reliability and lifetime.
- (2) The inputs are protected by ESD protection diodes to each power supply. If the input extends more than 300 mV beyond the power supply, the input current should be limited to less than 10 mA.
- (3) Power dissipation and thermal limits must be observed.

ESD, Electrostatic Discharge Protection

Parameter		Condition	Minimum Level	Unit
HBM	Human Body Model ESD	ANSI/ESDA/JEDEC JS-001 ⁽¹⁾	±6	kV
CDM	Charged Device Model ESD	ANSI/ESDA/JEDEC JS-002 ⁽²⁾	±1.5	kV

- (1) JEDEC document JEP155 states that 500-V HBM allows safe manufacturing with a standard ESD control process.
- (2) JEDEC document JEP157 states that 250-V CDM allows safe manufacturing with a standard ESD control process.

Recommended Operating Conditions

Parameter		Min	Max	Unit
	Power Supply Voltage, VDD	4.5	23	V
	Input Voltage Range INA, INB, INA+, INA-, INB+, INB-, ENA, ENB	0	20	V
	Operating Ambient Temperature Range	-40	125	°C

Dual 5-A High-speed, Low-side Gate Driver**Thermal Information**

Package Type	θ_{JA}	θ_{JC}	Unit
SOP8	122.3	60.4	°C/W
EMSOP8	63.0	42.6	°C/W
DFN3X3-8	75	33	°C/W
DFN2X2-8	55	50	°C/W

Dual 5-A High-speed, Low-side Gate Driver
Electrical Characteristics

All test conditions: $V_{DD} = 12\text{ V}$, $T_J = -40\text{ }^\circ\text{C}$ to $150\text{ }^\circ\text{C}$, and $1\text{-}\mu\text{F}$ capacitor between V_{DD} and GND, unless otherwise noted.

Parameter		Conditions	Min	Typ	Max	Unit
$I_{DD(\text{off})}$	Start-up Current, based on TPM27524 Circuitry	$V_{DD} = 3.4\text{ V}$, $INA = H$, $INB = H$		40	100	μA
		$V_{DD} = 3.4\text{ V}$, $INA = L$, $INB = L$		40	100	
V_{ON}	Supply Under Voltage Lock Out Rising Threshold	$T_J = 25\text{ }^\circ\text{C}$	3.91	4.2	4.5	V
		$T_J = -40\text{ }^\circ\text{C} - 150\text{ }^\circ\text{C}$	3.7	4.2	4.65	
V_{OFF}	Supply Under Voltage Lock Out Falling Threshold	$T_J = -40\text{ }^\circ\text{C} - 150\text{ }^\circ\text{C}$	3.4	3.9	4.4	V
V_{DD_H}	Supply Under Voltage Lock Out Hysteresis		0.2	0.3	0.5	V
V_{EN_H}	Enable High Threshold	Enable high threshold		1.9	2.3	V
V_{EN_L}	Enable Low Threshold	Enable low threshold	1	1.2		V
V_{EN_HYS}	Enable Hysteresis			0.7		V
V_{IN_H}	Input Signal High Threshold	Input high threshold		1.95	2.3	V
V_{IN_L}	Input Signal Low Threshold	Input low threshold	1	1.25		V
V_{IN_HYS}	Input Hysteresis			0.7		V
I_{OUT}	Output Peak Current	$C_{LOAD} = 0.22\text{ }\mu\text{F}$, $F_{SW} = 1\text{ kHz}$		± 5		A
$V_{DD} - V_{OH}$	Output High Voltage	$I_{OUT} = -10\text{ mA}$			40	mV
V_{OL}	Output Low Voltage	$I_{OUT} = 10\text{ mA}$			10	mV
R_{OH}	Output Pull-up Resistance, PMOS Pull-up only	$I_{OUT} = -10\text{ mA}$	1	1.6	3	Ω
R_{OL}	Output Pull-down Resistance	$I_{OUT} = 10\text{ mA}$	0.15	0.5	1	Ω
t_R	Output Rise-time	$C_{LOAD} = 1.8\text{ nF}$		7	18	ns
t_F	Output Fall-time	$C_{LOAD} = 1.8\text{ nF}$		6	10	ns
t_M	Delay Matching between OUTA and OUTB	$INA = INB$, OUTA and OUTB measured at 50%		1	4	ns
t_{PW}	Minimal Pulse Width			15	25	ns
t_{D1}	Input to Output Propagation Delay	$C_{LOAD} = 1.8\text{ nF}$, 5-V INx pulse	6	14	23	ns
t_{D2}	Input to Output Propagation Delay	$C_{LOAD} = 1.8\text{ nF}$, 5-V INx pulse	6	14	23	ns

Dual 5-A High-speed, Low-side Gate Driver

Parameter		Conditions	Min	Typ	Max	Unit
t_{D3}	Enable to Output Propagation Delay	$C_{LOAD} = 1.8 \text{ nF}$, 5-V ENx pulse	6	14	23	ns
t_{D4}	Enable to Output Propagation Delay	$C_{LOAD} = 1.8 \text{ nF}$, 5-V ENx pulse	6	14	23	ns

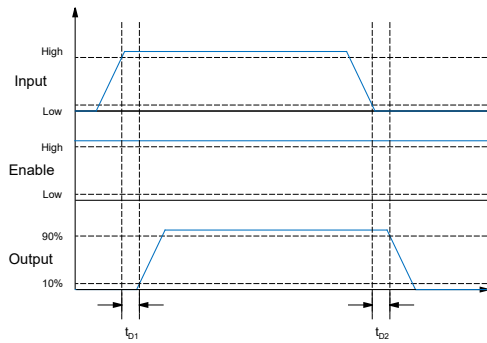
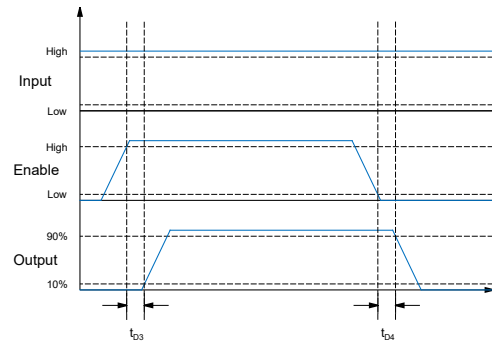
Figure 1. Input Timing Diagram

Figure 2. Enable Timing Diagram

Typical Performance Characteristics

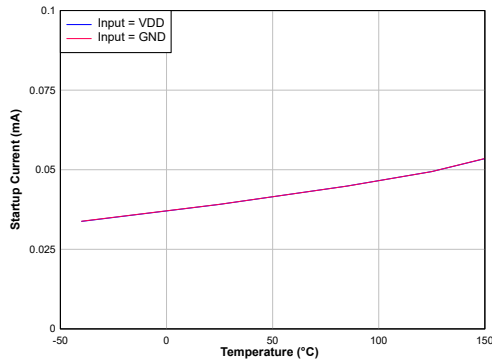

Figure 3. Start-up Current vs. Temperature

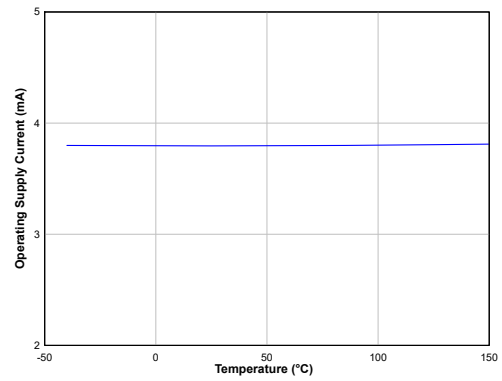

Figure 4. Operating Current vs Ambient Temperature

f = 500 kHz, C_L = 500 pF, V_{DD} = 12 V

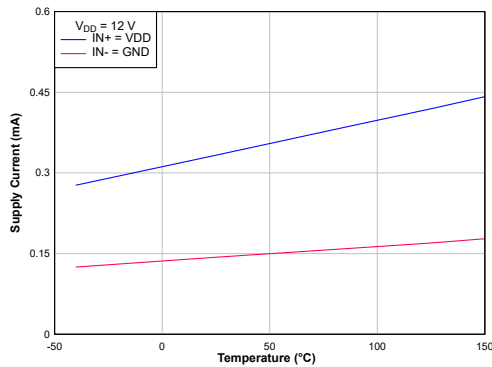

Figure 5. Supply Current vs Temperature (On/Off)

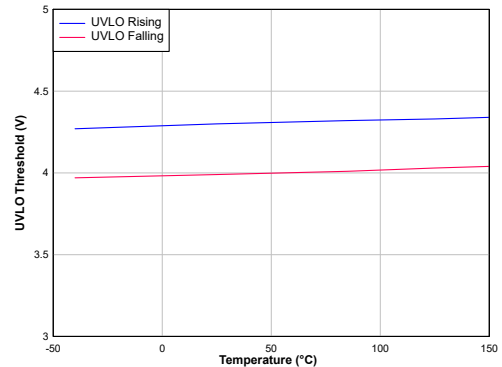

Figure 6. UVLO Threshold vs Temperature

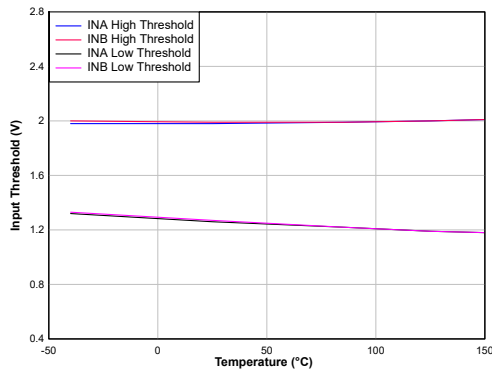

Figure 7. Input Threshold vs Temperature

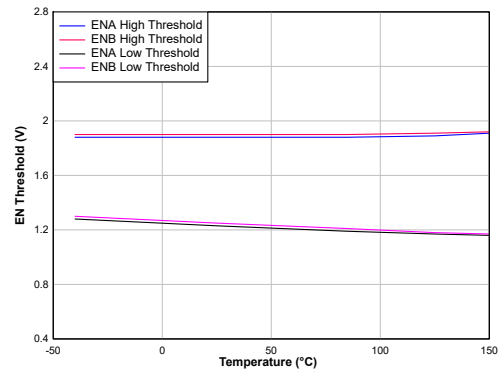

Figure 8. Enable Threshold vs Temperature

Dual 5-A High-speed, Low-side Gate Driver

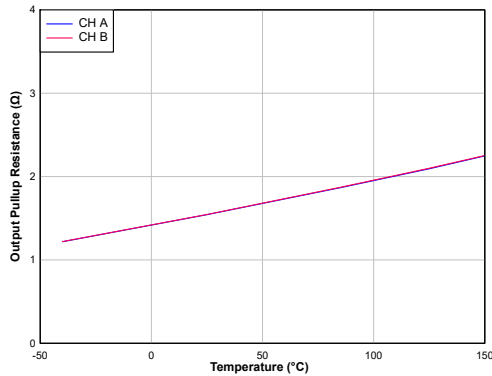

Figure 9. Output Pull-up Resistance vs Temperature

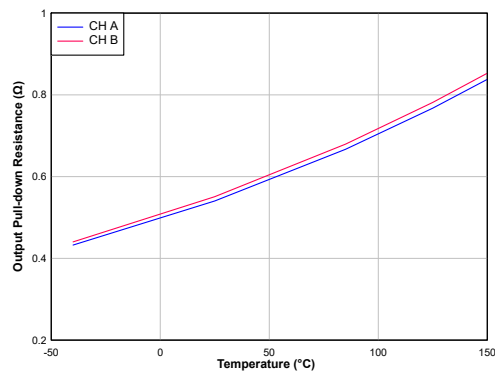

Figure 10. Output Pull-down Resistance vs Temperature

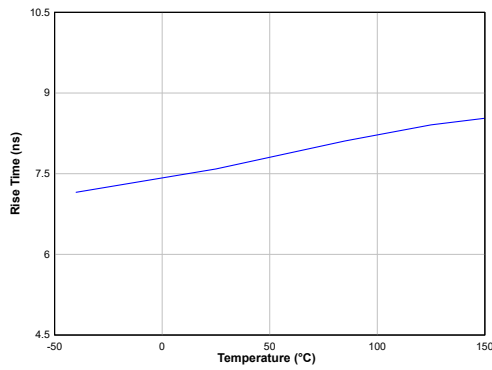

Figure 11. Rise-time vs Temperature

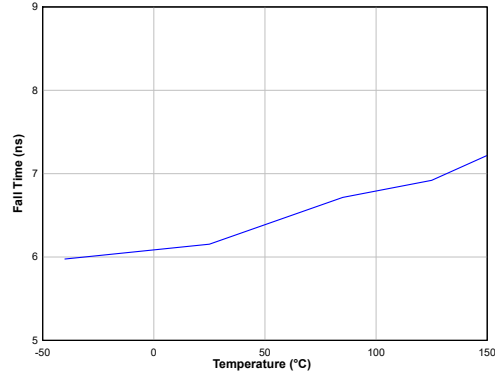

Figure 12. Fall-time vs Temperature

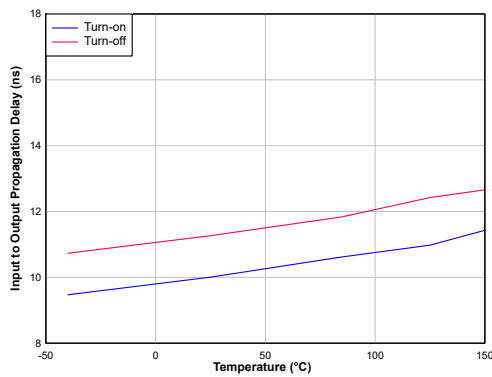

Figure 13. Input to Output Propagation Delay vs Temperature

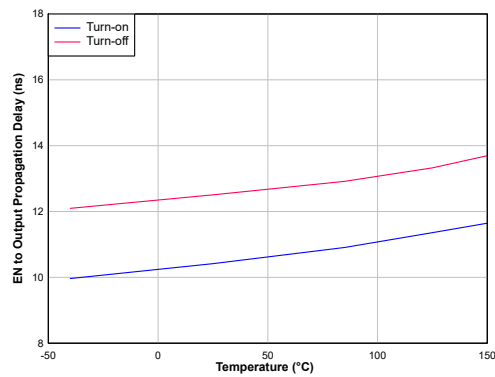

Figure 14. Enable to Output Propagation Delay vs Temperature

Dual 5-A High-speed, Low-side Gate Driver

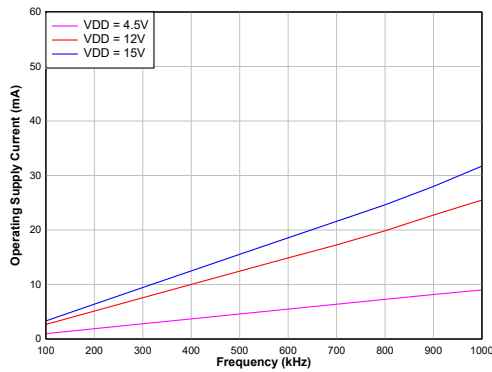

Figure 15. Operating Supply Current vs Frequency

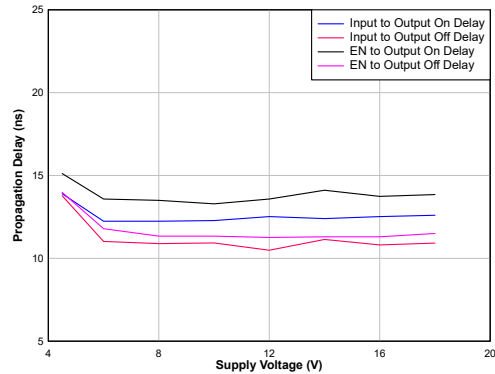

Figure 16. Propagation Delay vs Supply Voltage

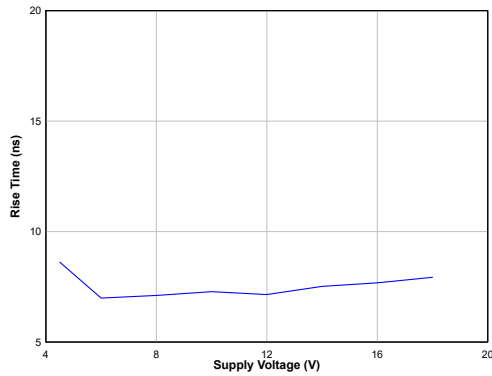

Figure 17. Rise-time vs Supply Voltage

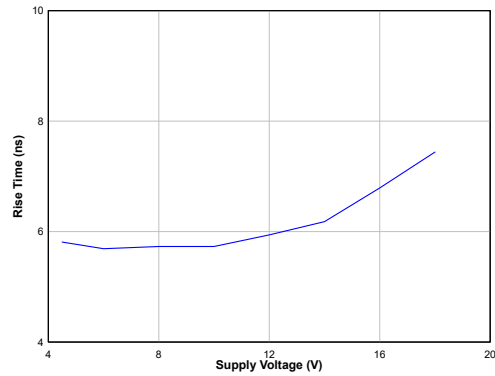

Figure 18. Fall-time vs Supply Voltage

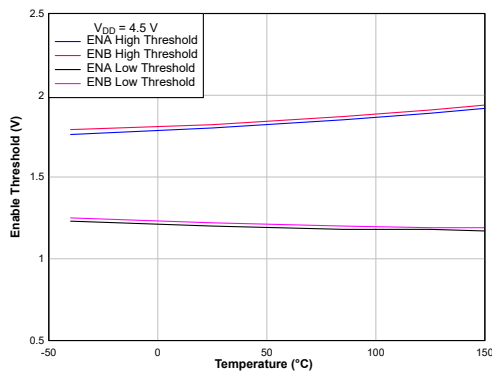

Figure 19. Enable Threshold vs Temperature

VDD = 4.5 V

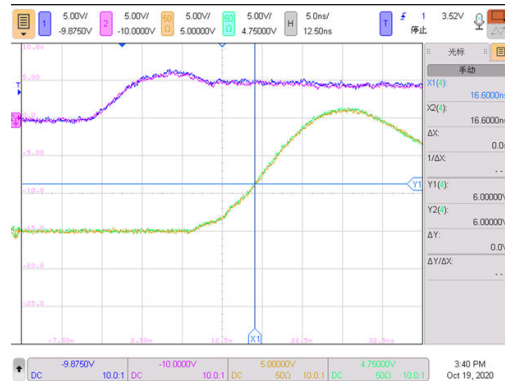

Figure 20. Rising Edge

Dual 5-A High-speed, Low-side Gate Driver

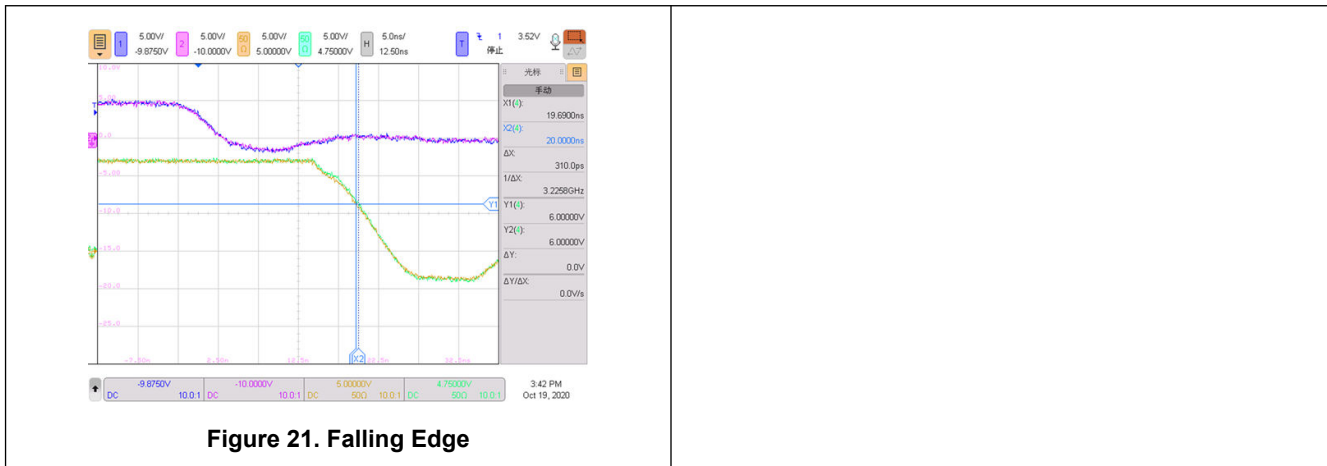

Figure 21. Falling Edge

Detailed Description

Overview

The TPM2752x series of dual-channel low-side gate drivers are designed for high-performance power supplies, motor controls, and inverters. Designed with industrial standard pin-out and package, the TPM2752x accelerates design process. With extended voltage ranges of supply voltage and negative input voltage on inputs, the TPM2752x improves system-level reliability. 5-A strong driving capability improves gate driver efficiency and lowers heat generation, especially in high-frequency switching applications.

Functional Block Diagram

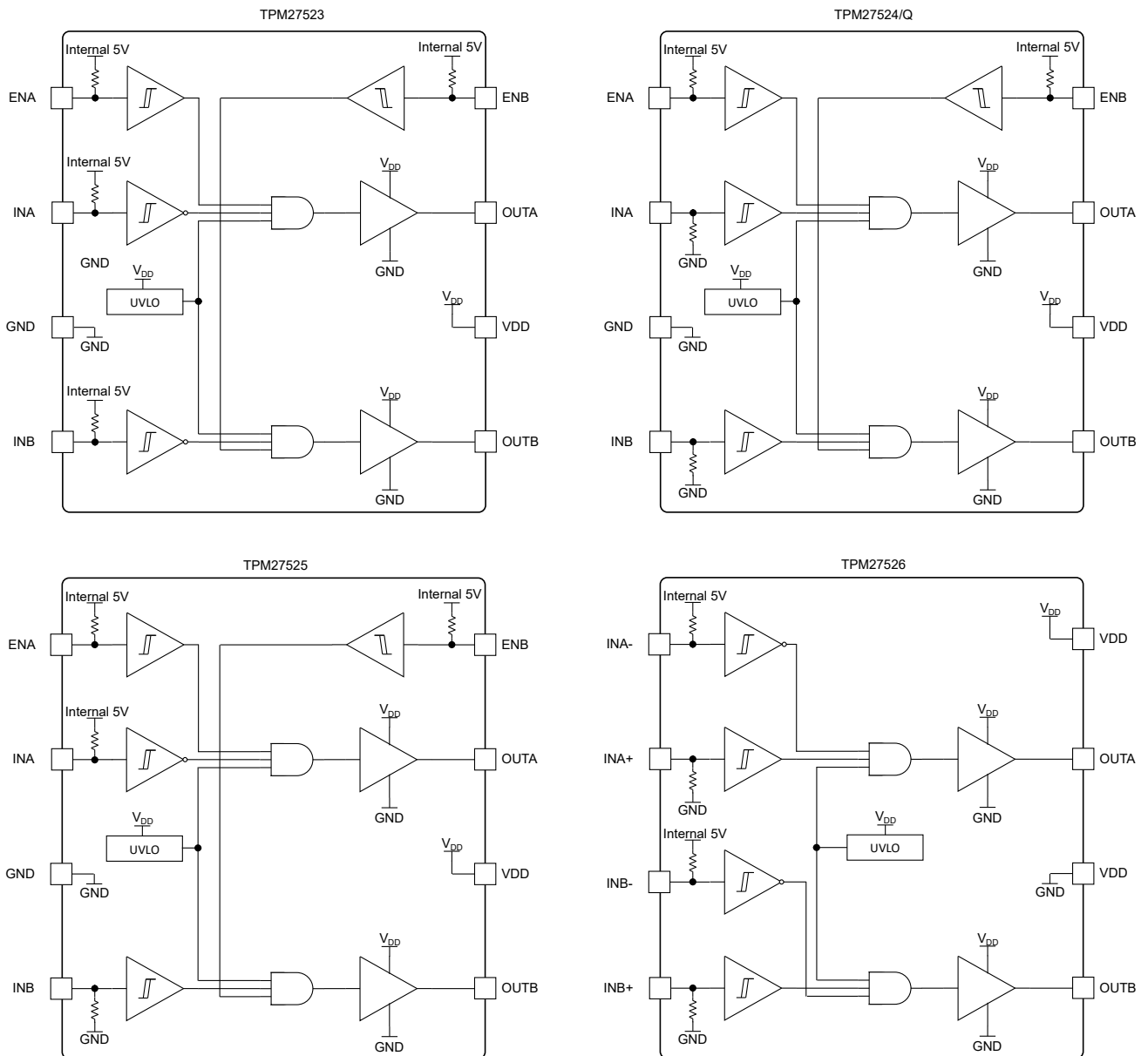

Figure 22. Functional Block Diagram

Feature Description

Low Propagation Delay Driver Outputs

The low-propagation-delay design allows the device to achieve industrial leading low propagation delay between inputs and outputs. The low delay enhances driver performance in high-frequency switching regulators. Matching between two channels is optimized to support parallel driving. 3PEAK recommends tying IN1 and IN2 locally together with a high-input slew rate, to avoid shoot-through between the two well-matched channels. Capacitors are not recommended on IN1 and IN2 nodes when used in parallel.

Supply and UVLO

The device monitors the supply voltage with under-voltage lock-out (UVLO). When the supply voltage is below the UVLO threshold, the outputs are held low in UVLO to avoid glitches during power rising and falling.

The device quiescent current and operating current are measured as shown in Figure 5. The current is related to internal quiescent current consumption as well as the output current. The output current can be calculated using external transistor gate charge times switching frequency f_{sw} .

Channel Input

The input of the TPM2752x gate drivers supports TTL and CMOS input with the threshold voltage independent of the supply voltage. The threshold is also designed to support a wide range of ambient temperatures. Wide hysteresis enhances system-level noise immunity. The integrated pull-up and pull-down resistors set the device state when inputs are floating. EN supports NC connection with the help of internal pull-up resistors.

Inputs can withstand DC $-5V$, to improve robustness on ground bouncing.

Output Stage

The TPM2752x output stage is able to deliver high current sourcing and sinking up to 5 A with low propagation delay. The delay matching between dual channels is also optimized within 1-ns.

In the case of higher output driving capabilities needed, the TPM2752x can allow paralleling the dual channel to achieve a higher driving current. In this case, it is recommended to use a high slew rate on IN1 and IN2 and connect IN1 and IN2 to avoid shoot through between channels.

Tape and Reel Information

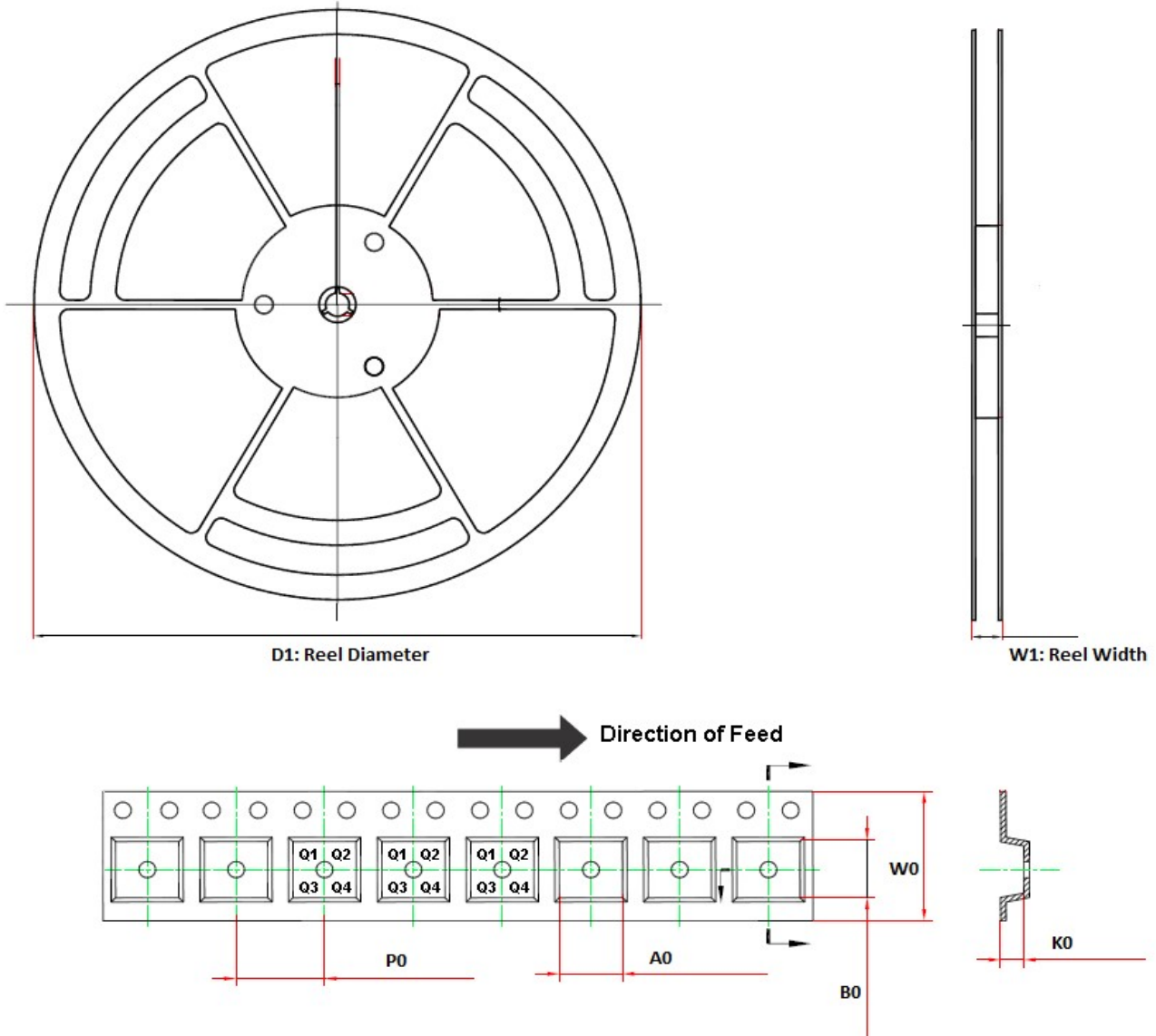

Order Number	Package	D1 (mm)	W1 (mm)	A0 (mm)	B0 (mm)	K0 (mm)	P0 (mm)	W0 (mm)	Pin1 Quadrant
TPM27523-SO1R	SOP8	330.0	17.6	6.4	5.4	2.1	8.0	12.0	Q1
TPM27524-DF4R	DFN2X2-8	180.0	13.1	2.3	2.3	1.1	4.0	8.0	Q1
TPM27524-DF6R	DFN3X3-8	330.0	17.6	3.3	3.3	1.1	8.0	12.0	Q1
TPM27524-EV1R	EMSOP8	330.0	17.6	5.2	3.3	1.5	8.0	12.0	Q1

Dual 5-A High-speed, Low-side Gate Driver

Order Number	Package	D1 (mm)	W1 (mm)	A0 (mm)	B0 (mm)	K0 (mm)	P0 (mm)	W0 (mm)	Pin1 Quadrant
TPM27524-SO1R	SOP8	330.0	17.6	6.4	5.4	2.1	8.0	12.0	Q1
TPM27524-SO1R-S	SOP8	330.0	17.6	6.4	5.4	2.1	8.0	12.0	Q1
TPM27524-SO1R	SOP8	330.0	17.6	6.4	5.4	2.1	8.0	12.0	Q1
TPM27525-SO1R	SOP8	330.0	17.6	6.4	5.4	2.1	8.0	12.0	Q1
TPM27526-DF6R	DFN3X3-8	330.0	17.6	3.3	3.3	1.1	8.0	12.0	Q2
TPM27526-DF6R-S	DFN3X3-8	330.0	17.6	3.3	3.3	1.1	8.0	12.0	Q2
TPM27524-EV1R	EMSOP8	330.0	17.6	5.2	3.3	1.5	8.0	12.0	Q1

Package Outline Dimensions

SOP8

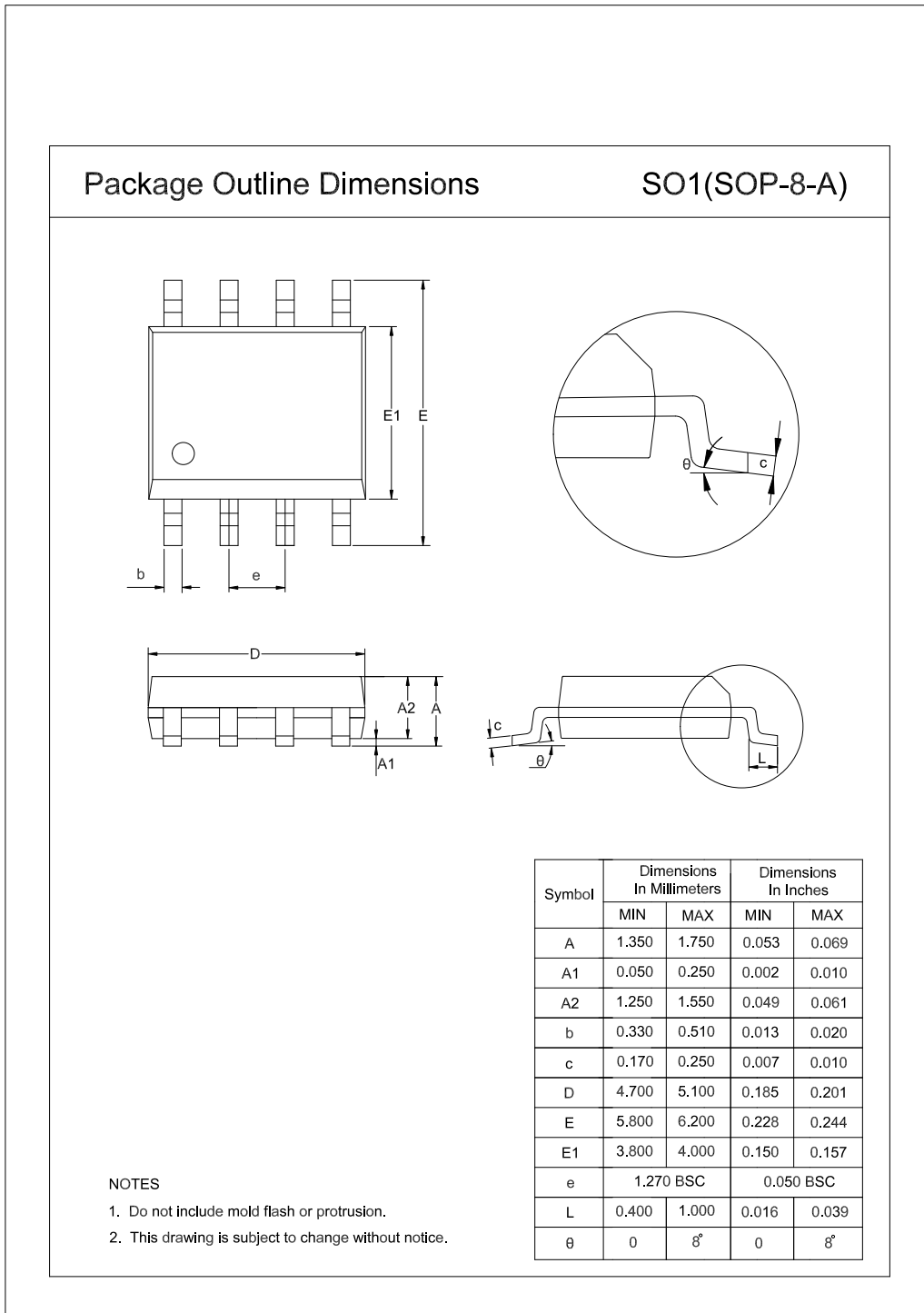

EMSOP8

Package Outline Dimensions

EV1(EMSOP-8-A)

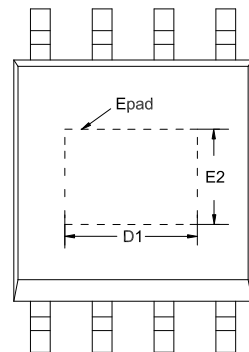
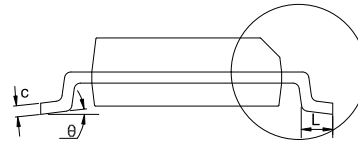
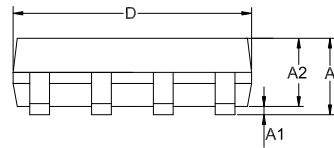
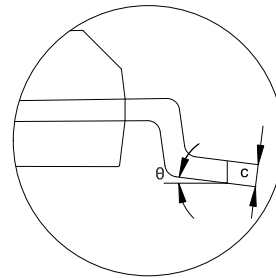
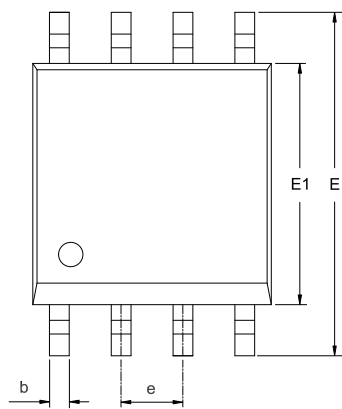

Symbol	Dimensions In Millimeters		Dimensions In Inches	
	MIN	MAX	MIN	MAX
A	0.800	1.100	0.031	0.043
A1	0.050	0.150	0.002	0.006
A2	0.750	0.950	0.030	0.037
b	0.250	0.380	0.010	0.015
c	0.090	0.230	0.004	0.009
D	2.900	3.100	0.114	0.122
D1	1.700	1.900	0.067	0.075
E	4.700	5.100	0.185	0.201
E1	2.900	3.100	0.114	0.122
E2	1.450	1.650	0.057	0.065
e	0.650 BSC		0.026 BSC	
L	0.400	0.800	0.016	0.031
θ	0	8°	0	8°

NOTES

1. Do not include mold flash or protrusion.
2. This drawing is subject to change without notice.

DFN2x2-8

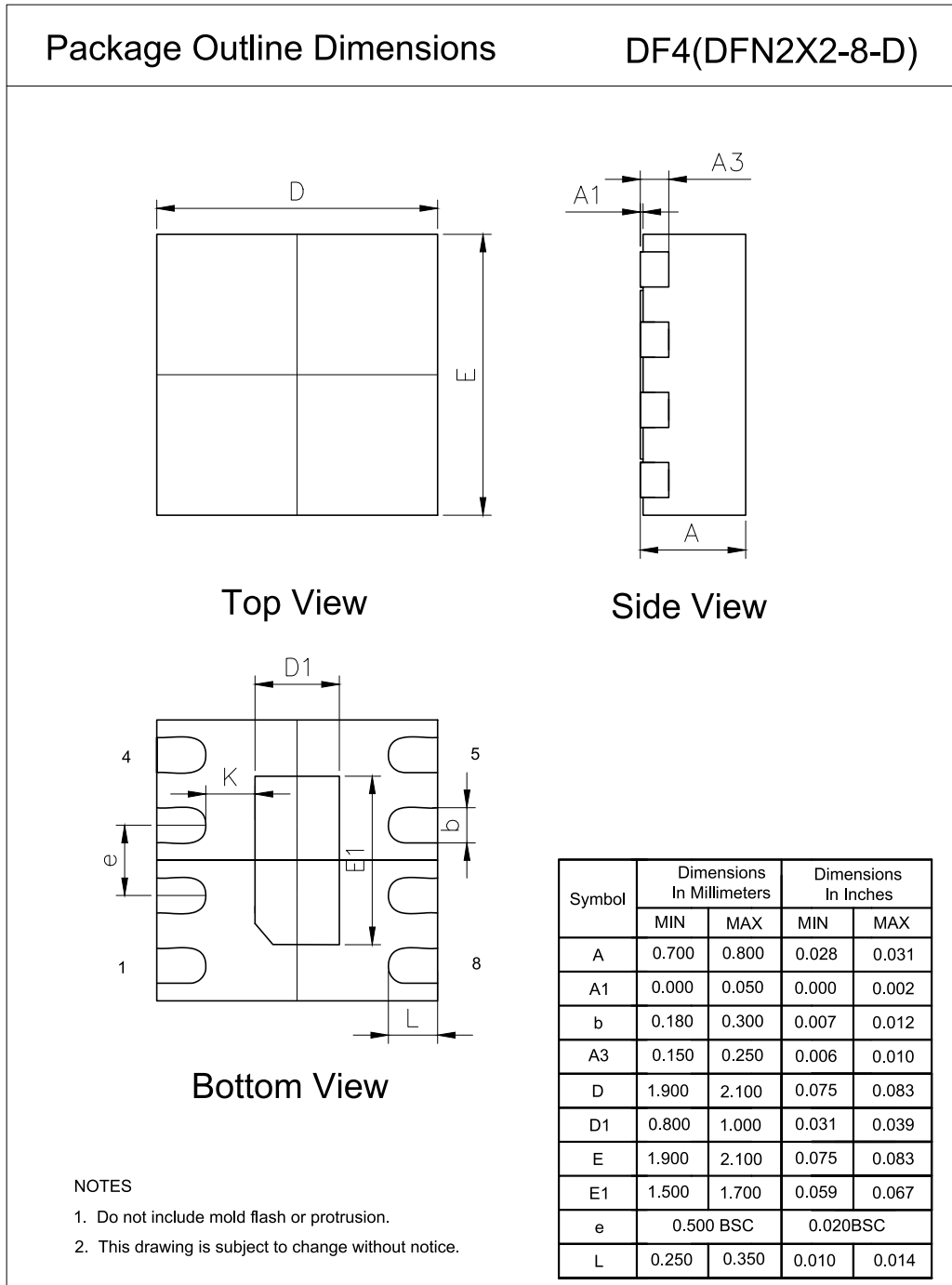

DFN3X3-8

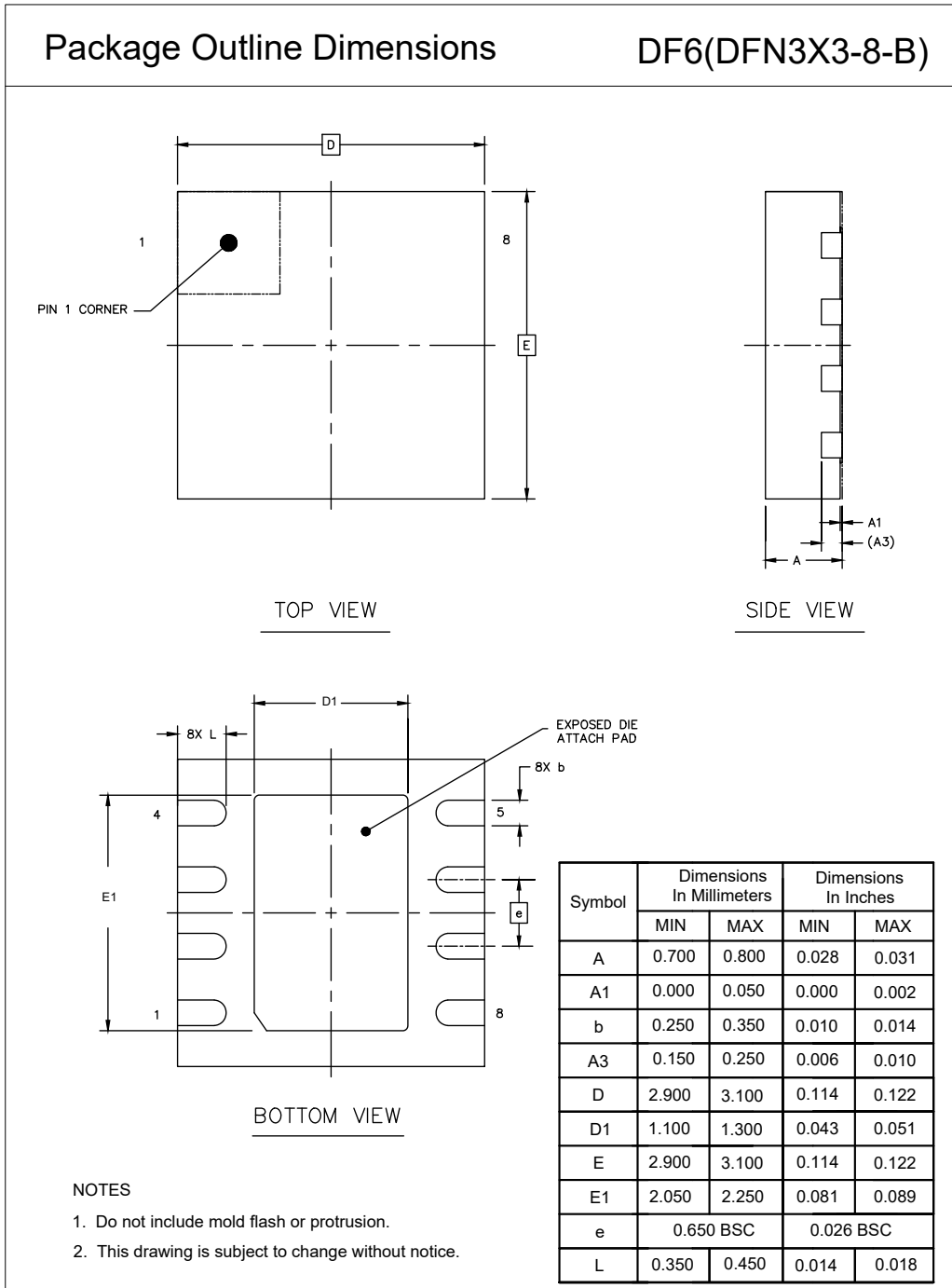

This page intentionally left blank

Order Information

Order Number	Operating Ambient Temperature Range	Package	Marking Information	MSL	Transport Media, Quantity	Eco Plan
TPM27523-SO1R	-40 °C to 125 °C ⁽¹⁾	SOP8	M523	3	Tape and Reel, 4000	Green
TPM27523-EV1R	-40 °C to 125 °C ⁽¹⁾	EMSOP8	M523	3	Tape and Reel, 3000	Green
TPM27524-DF4R	-40 °C to 125 °C ⁽¹⁾	DFN2X2-8	M524	3	Tape and Reel, 3000	Green
TPM27524-DF6R	-40 °C to 125 °C ⁽¹⁾	DFN3X3-8	M524	3	Tape and Reel, 4000	Green
TPM27524-EV1R	-40 °C to 125 °C ⁽¹⁾	EMSOP8	M524	3	Tape and Reel, 3000	Green
TPM27524-SO1R	-40 °C to 125 °C ⁽¹⁾	SOP8	M524	3	Tape and Reel, 4000	Green
TPM27524-SO1R-S	-40 °C to 125 °C ⁽¹⁾	SOP8	M524	3	Tape and Reel, 4000	Green
TPM27525-SO1R	-40 °C to 125 °C ⁽¹⁾	SOP8	M525	3	Tape and Reel, 4000	Green
TPM27526-DF6R	-40 °C to 125 °C ⁽¹⁾	DFN3X3-8	M526	2	Tape and Reel, 4000	Green
TPM27526-DF6R-S	-40 °C to 125 °C ⁽¹⁾	DFN3X3-8	M526	2	Tape and Reel, 4000	Green
TPM27526-SO1R	-40 °C to 125 °C ⁽¹⁾	EMSOP8	M526	3	Tape and Reel, 4000	Green

(1) Ambient temperature indicates device operation condition range. Application thermal behavior needs to be taken care of when operating in high-temperature scenarios.

(2) Contact 3PEAK representatives for more information.

Green: 3PEAK defines "Green" to mean RoHS compatible and free of halogen substances.



3PEAK and the 3PEAK logo are registered trademarks of 3PEAK INCORPORATED. All other trademarks are the property of their respective owners.
