



# STPS0540Z / STPS0560Z

## SCHOTTKY RECTIFIER

### MAIN PRODUCT CHARACTERISTICS

$I_{F(AV)}$	0.5 A
$V_{RRM}$	40 / 60V
$V_F$ (max)	0.40 / 0.50V

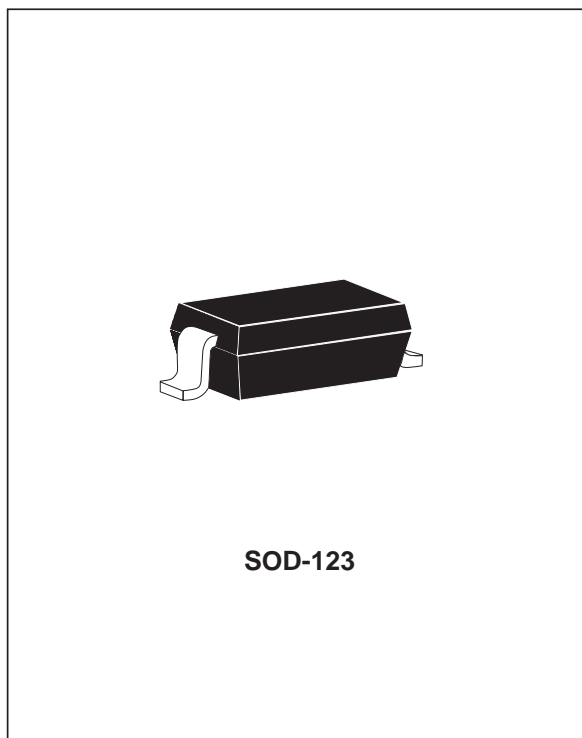
### FEATURES AND BENEFITS

- Very small conduction losses
- Negligible switching losses
- Extremely fast switching

### DESCRIPTION

Single Schottky rectifier suited for switch mode power supplies and high frequency DC to DC converters.

Packages in SOD-123, these devices are intended for use in low voltage, high frequency inverters, free wheeling and polarity protection applications. Due to the small size of the package these devices fit GSM and PCMCIA requirements.



### ABSOLUTE RATINGS (limiting values)

Symbol	Parameter	Value		Unit
		STPS		
		0540Z	0560Z	
$V_{RRM}$	Repetitive peak reverse voltage	40	60	V
$I_{F(RMS)}$	RMS forward current	2		A
$I_{F(AV)}$	Average forward current $\delta=0.5$	STPS0540Z Ta= 60°C	0.5	A
$I_{FSM}$	Surge non repetitive forward current	STPS0560Z Ta= 40°C	5.5	A
dV/dt	Critical rate of rise of reverse voltage	tp=10ms sinusoidal	10000	V/μs
$T_{stg}$	Storage temperature range		- 65 to + 150	°C
$T_j$	Maximum operating junction temperature *		150	°C
TL	Maximum temperature for soldering during 10s		260	°C

\* :  $\frac{dP_{tot}}{dT_j} < \frac{1}{R_{th(j-a)}}$  thermal runaway condition for a diode on its own heatsink

## STPS0540Z / STPS0560Z

### THERMAL RESISTANCE

Symbol	Parameter	Value	Unit
$R_{th(j-a)}$	Junction to ambient (*)	340	°C/W

(\*) Mounted on epoxy board.

### STATIC ELECTRICAL CHARACTERISTICS

Symbol	Parameter	Tests conditions		Value				Unit
				STPS0540Z		STPS0560Z		
				typ.	max.	typ.	max.	
$I_R^*$	Reverse leakage current	$T_j=25^\circ\text{C}$	$V_R = V_{RRM}$		40		50	$\mu\text{A}$
		$T = 100^\circ\text{C}$		1.5	5	1	4	mA
$V_F^{**}$	Forward voltage drop	$T_j=25^\circ\text{C}$	$I_F = 0.5 \text{ A}$		0.50		0.53	V
		$T_j=100^\circ\text{C}$		0.35	0.40	0.44	0.50	
		$T_j=25^\circ\text{C}$	$I_F = 1 \text{ A}$		0.55		0.66	
		$T_j=100^\circ\text{C}$		0.45	0.51	0.58	0.65	

Pulse test : \*  $t_p = 5 \text{ ms}$ ,  $\delta < 2\%$

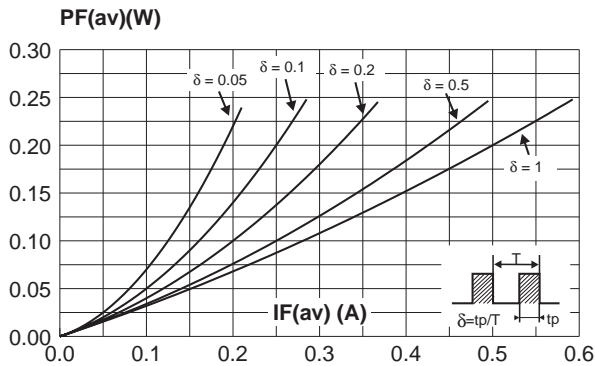
\*\*  $t_p = 380 \mu\text{s}$ ,  $\delta < 2\%$

To evaluate the maximum conduction losses use the following equation :

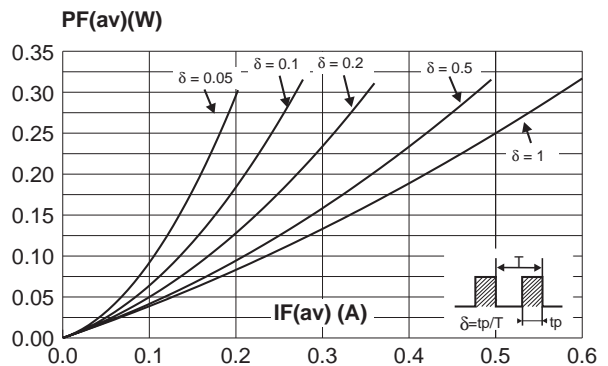
$$\text{STPS0540Z: } P = 0.29 \times I_{F(AV)} + 0.22 \times I_F^2(\text{RMS})$$

$$\text{STPS0560Z: } P = 0.35 \times I_{F(AV)} + 0.3 \times I_F^2(\text{RMS})$$

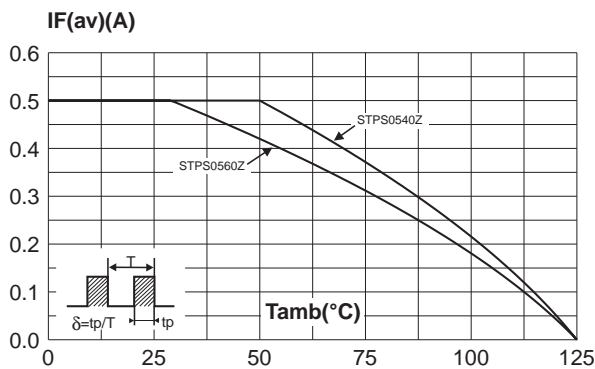
**Fig. 1-1:** Average forward power dissipation versus average forward current.(STPS0540Z)



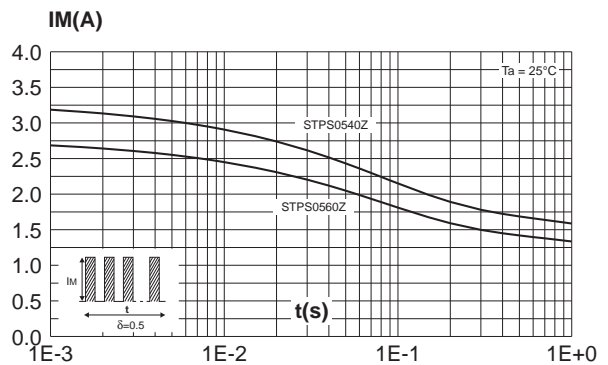
**Fig. 1-2:** Average forward power dissipation versus average forward current.(STPS0560Z)



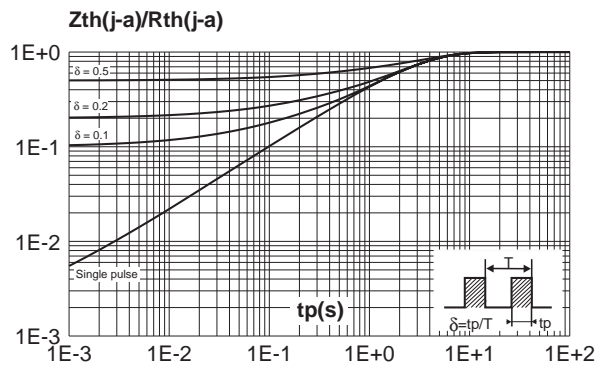
**Fig. 2:** Average forward current versus ambient temperature ( $\delta = 0.5$ ).



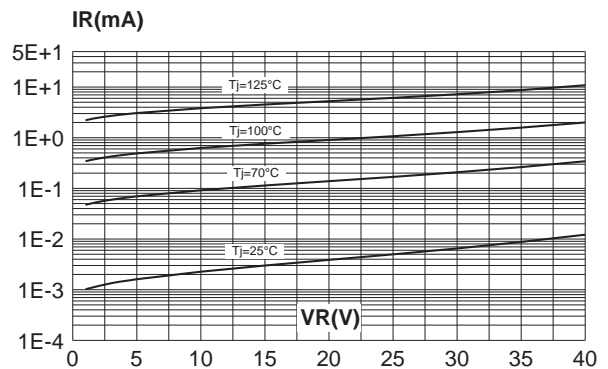
**Fig. 3:** Non repetitive surge peak forward current versus overload duration (maximum values).



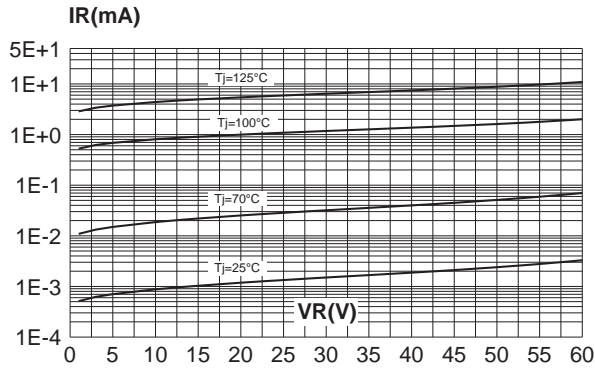
**Fig. 4:** Relative variation of thermal impedance junction to ambient versus pulse duration (Epoxy printed circuit board FR4 with recommended pad layout).



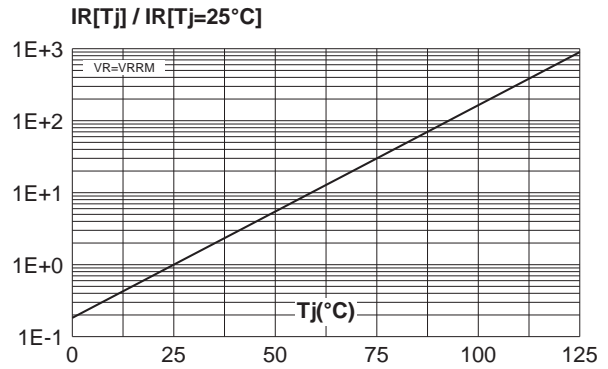
**Fig. 5-1:** Reverse leakage current versus reverse voltage applied (typical values).(STPS0540Z)



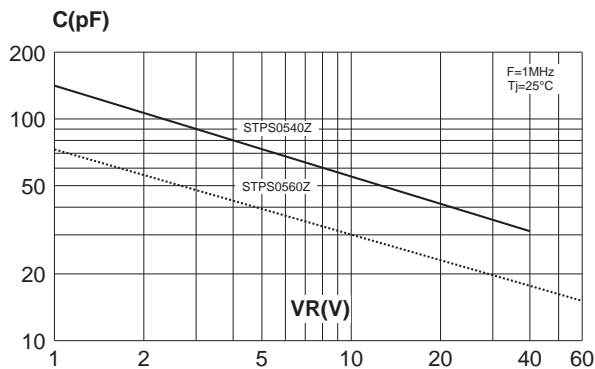
**Fig. 5-2:** Reverse leakage current versus reverse voltage applied (typical values).(STPS0560Z)



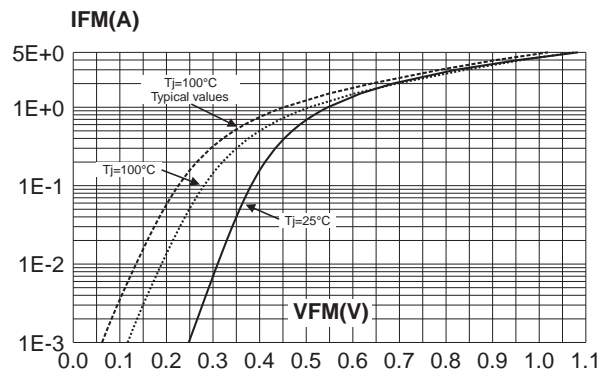
**Fig. 6:** Reverse leakage current versus junction temperature (typical values).



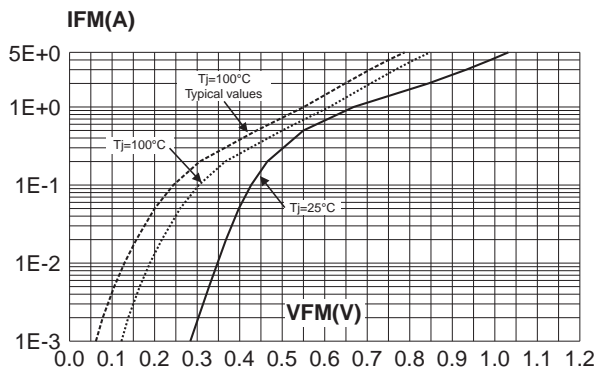
**Fig. 7:** Junction capacitance versus reverse voltage applied (typical values).



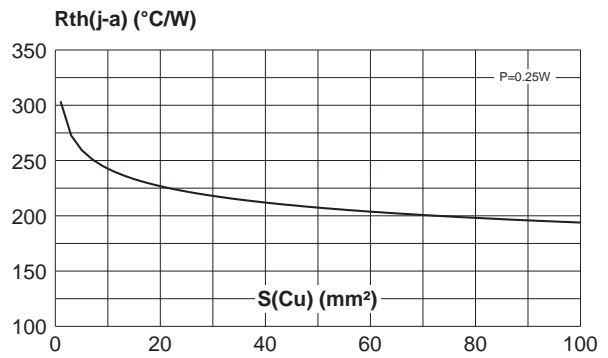
**Fig. 8-1:** Forward voltage drop versus forward current (maximum values).(STPS0540Z)

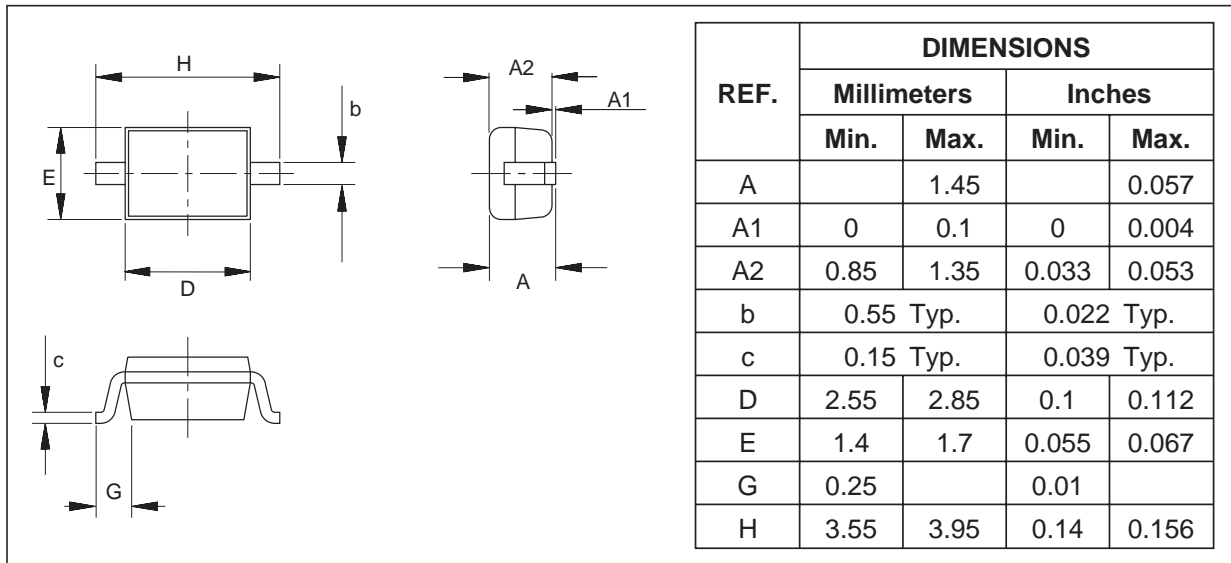
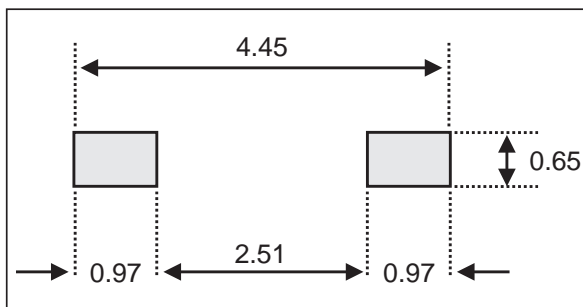


**Fig. 8-2:** Forward voltage drop versus forward current (maximum values).(STPS0560Z)



**Fig. 9:** Variation of thermal resistance junction to ambient versus copper surface under each lead (Printed circuit board FR4, e(Cu) = 35µm).



**PACKAGE MECHANICAL DATA**  
 SOD-123

**FOOTPRINT (in millimeters)**

**MARKING**

Type	Marking	Package	Weight	Base qty	Delivery mode
STPS0540Z	Z54	SOD-123	0.01 g	3000	Tape & reel
STPS0560Z	Z56	SOD-123	0.01 g	3000	Tape & reel

- Epoxy meets UL94, V0.
- Band indicates cathode.

Information furnished is believed to be accurate and reliable. However, STMicroelectronics assumes no responsibility for the consequences of use of such information nor for any infringement of patents or other rights of third parties which may result from its use. No license is granted by implication or otherwise under any patent or patent rights of STMicroelectronics. Specifications mentioned in this publication are subject to change without notice. This publication supersedes and replaces all information previously supplied. STMicroelectronics products are not authorized for use as critical components in life support devices or systems without express written approval of STMicroelectronics.

The ST logo is a registered trademark of STMicroelectronics

© 2002 STMicroelectronics - Printed in Italy - All rights reserved.

STMicroelectronics GROUP OF COMPANIES

Australia - Brazil - Canada - China - Finland - France - Germany  
 Hong Kong - India - Israel - Italy - Japan - Malaysia - Malta - Morocco - Singapore  
 Spain - Sweden - Switzerland - United Kingdom - United States.

<http://www.st.com>