

Features

- High impedance value
- Current rating up to 400 mA
- RoHS compliant* and halogen free**

Applications

- Noise suppression
- Personal computers
- Display panels

SRF2012A Series - Common Mode Chip Inductors

Electrical Specifications

Part Number	Impedance @ 100 MHz		Rated Voltage (VDC)	Withstanding Voltage (DC)	Insulation Resistance (MΩ) Min.	DCR Max. (Ω)	IDC Max. (mA)
	(Ω)	Tolerance (%)					
SRF2012-300YA	30	±25	50	125	10	0.20	400
SRF2012-670YA	67	±25	50	125	10	0.25	400
SRF2012-900YA	90	±25	50	125	10	0.30	400
SRF2012-121YA	120	±25	50	125	10	0.30	400
SRF2012-161YA	160	±25	50	125	10	0.35	350
SRF2012-181YA	180	±25	50	125	10	0.35	350
SRF2012-201YA	200	±25	50	125	10	0.40	300
SRF2012-221YA	220	±25	50	125	10	0.40	300
SRF2012-261YA	260	±25	50	125	10	0.40	300
SRF2012-301YA	300	±25	50	125	10	0.50	300
SRF2012-361YA	360	±25	50	125	10	0.50	300
SRF2012-371YA	370	±25	50	125	10	0.50	300
SRF2012-501YA	500	±25	50	125	10	0.50	300
SRF2012-671YA	670	±25	50	125	10	0.60	140
SRF2012-901YA	900	±25	50	125	10	0.88	100

Soldering Profile

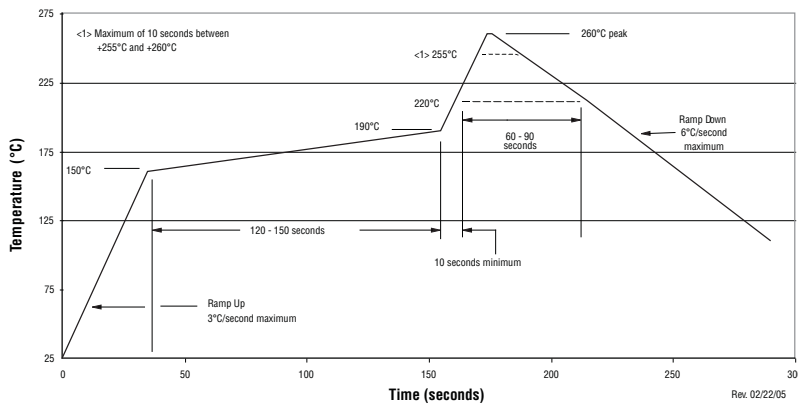

How to Order

SRF2012 - 201 Y A

Model _____
 Value Code (see table) _____
 Tolerance Code _____
 Model Suffix _____

Schematic

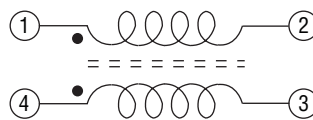

General Specifications

Reflow soldering 230 °C; 50 sec max.
 Operating Temperature
-55 °C to +125 °C
 (Temperature rise included)
 Storage Temperature
-55 °C to +125 °C
 Resistance to Soldering Heat
 260 °C, 10 sec. max.
 Temperature Rise30 °C max. at IDC

Materials

Core.....Ferrite
 Wire.....Enameled copper
 Terminal.....Ag/Ni/Sn
 Packaging..... 2000 pcs. per 7-inch reel

Product Dimensions

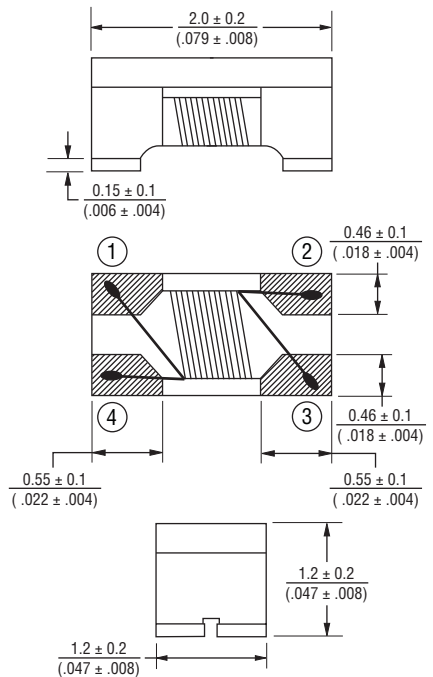

Recommended Layout

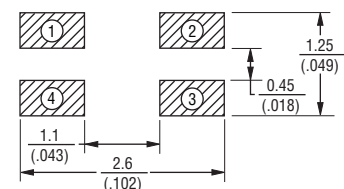

DIMENSIONS: MM (INCHES)

* RoHS Directive 2002/95/EC Jan. 27, 2003 including annex and RoHS Recast 2011/65/EU June 8, 2011.
 ** Bourns considers a product to be "halogen free" if (a) the Bromine (Br) content is 900 ppm or less;
 (b) the Chlorine (Cl) content is 900 ppm or less; and (c) the total Bromine (Br) and Chlorine (Cl) content is 1500 ppm or less.
 Specifications are subject to change without notice.
 The device characteristics and parameters in this data sheet can and do vary in different applications and actual device performance may vary over time.
 Users should verify actual device performance in their specific applications.

SRF2012A Series - Common Mode Chip Inductors

BOURNS®

Typical Impedance vs. Frequency Curves

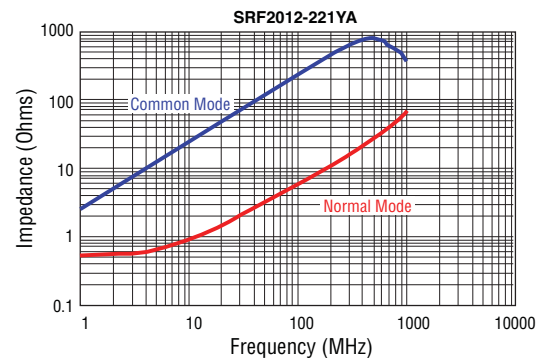
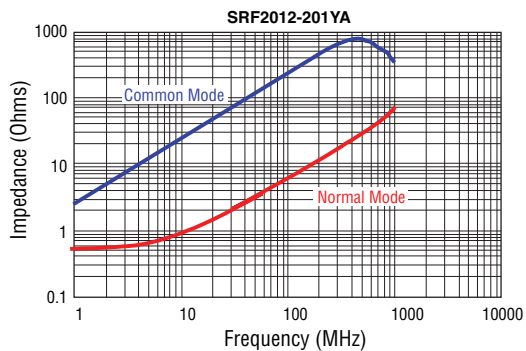
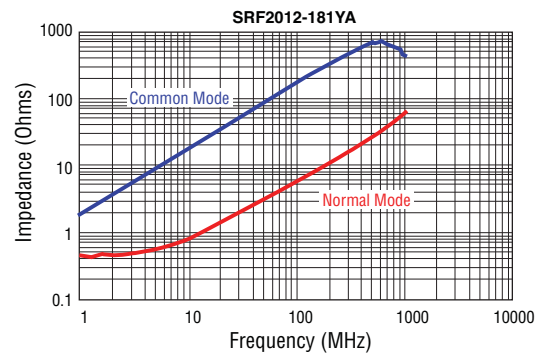
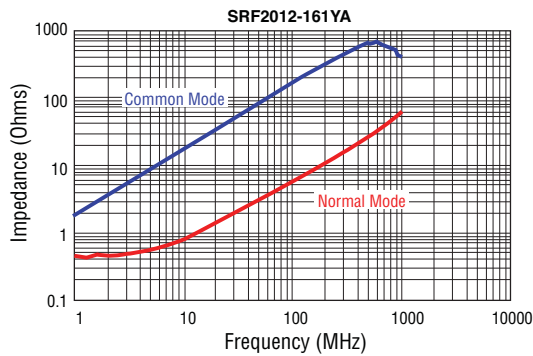
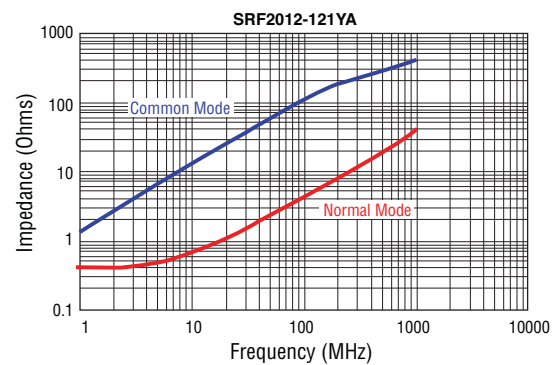
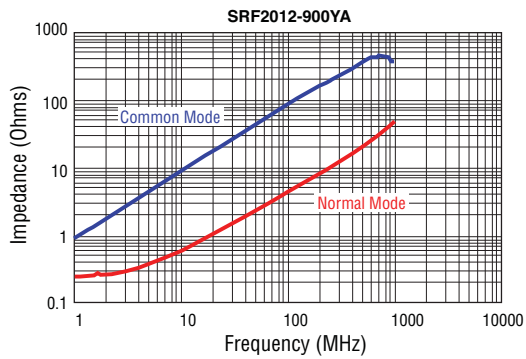
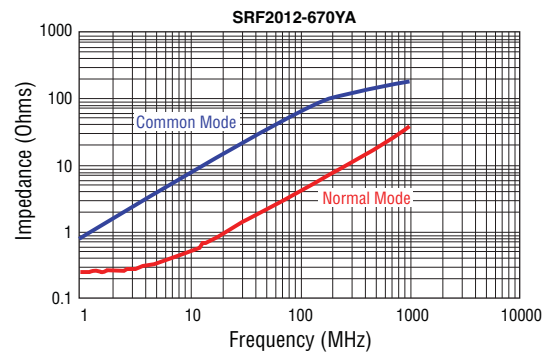
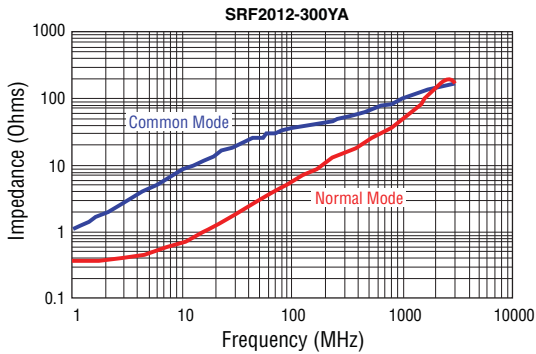

Specifications are subject to change without notice.
 The device characteristics and parameters in this data sheet can and do vary in different applications and actual device performance may vary over time.
 Users should verify actual device performance in their specific applications.

SRF2012A Series - Common Mode Chip Inductors

BOURNS®

Typical Impedance vs. Frequency Curves (Continued)

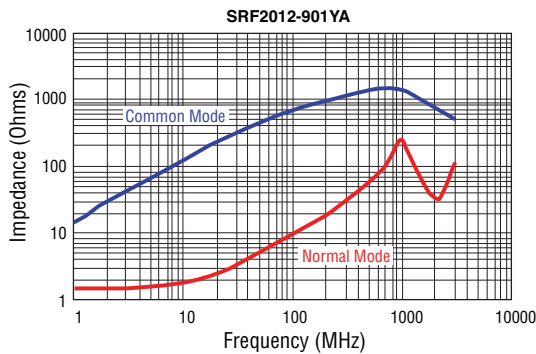
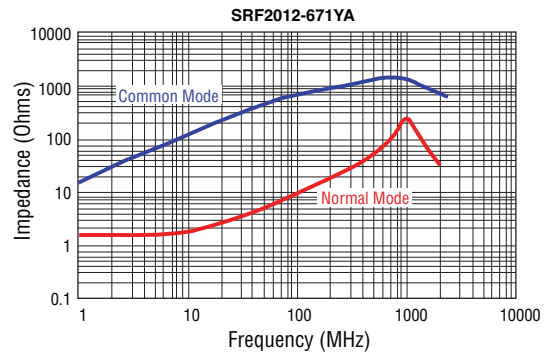
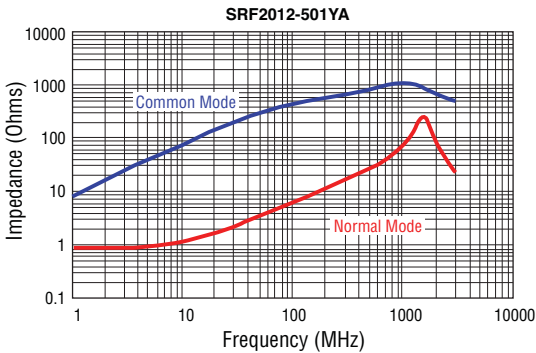
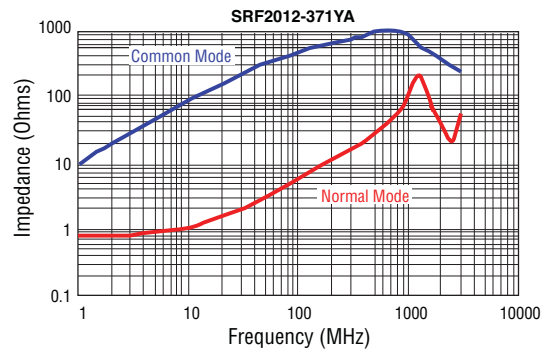
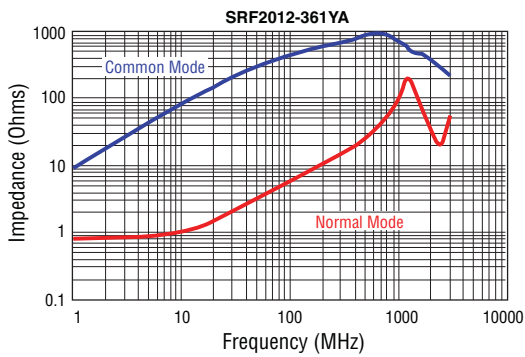
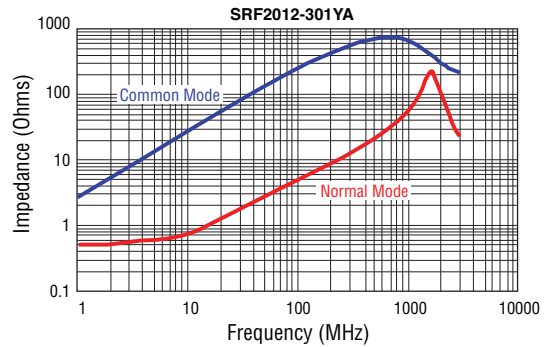
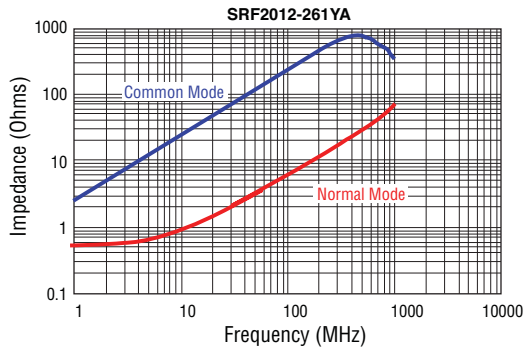

Specifications are subject to change without notice.

The device characteristics and parameters in this data sheet can and do vary in different applications and actual device performance may vary over time. Users should verify actual device performance in their specific applications.

SRF2012A Series - Common Mode Chip Inductors

BOURNS®

Packaging Specifications

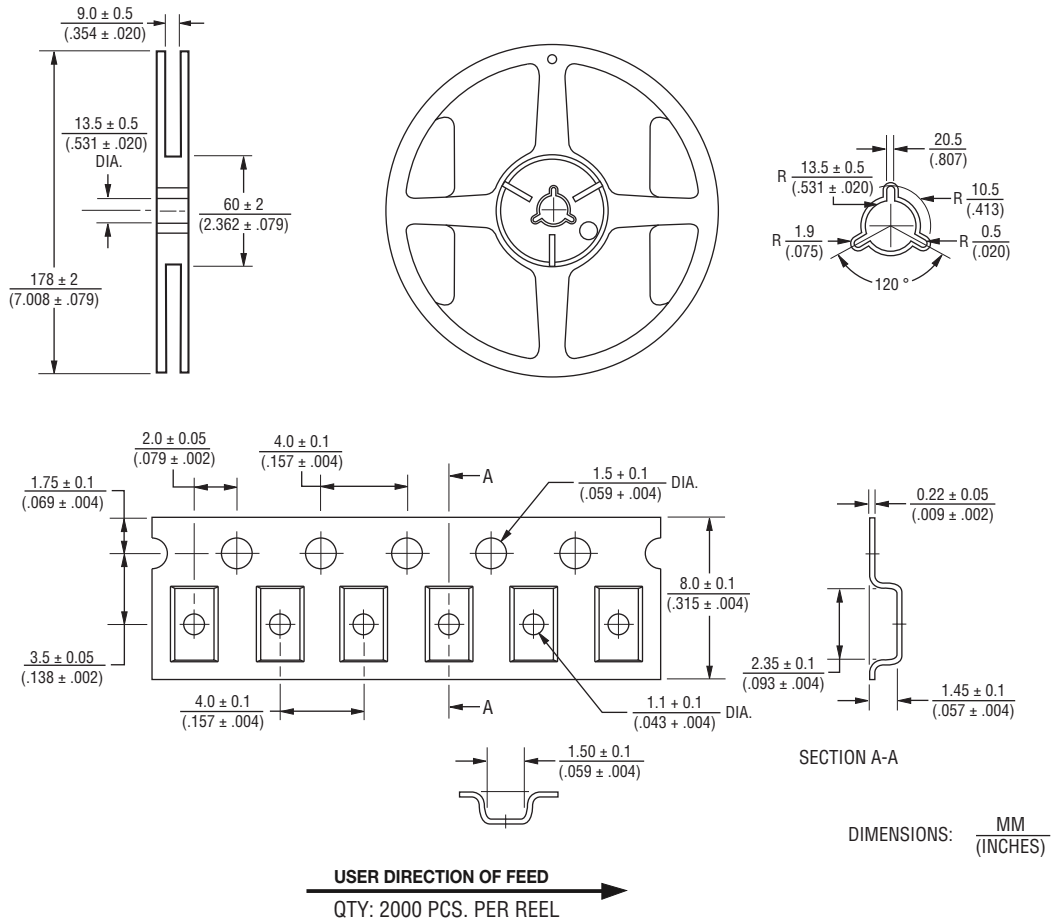

REV. 09/16

Specifications are subject to change without notice.

The device characteristics and parameters in this data sheet can and do vary in different applications and actual device performance may vary over time. Users should verify actual device performance in their specific applications.