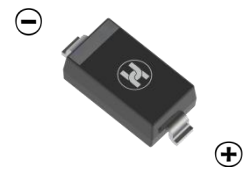
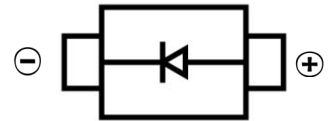

SWITCHING DIODE
FEATURES

- High Conductance
- Fast Switching
- Small Surface Mount device
- For General Purpose Switching Applications

SOD-123
MECHANICAL DATA

- Case: SOD-123
- Case Material: Molded Plastic. UL flammability
- Classification Rating: 94V-0
- Weight: 0.005 grams (approximate)
- Marking:T4

MAXIMUM RATINGS (T_A = 25°C unless otherwise noted)

Parameter	Symbol	Value	Unit
Non-Repetitive Peak Reverse Voltage	V _{RM}	100	V
DC Blocking Reverse Voltage	V _R	80	V
RMS Reverse Voltage	V _{R(RMS)}	80	V
Forward Current	I _F	300	mA
Average Rectified Output Current	I _O	100	mA
Non-Repetitive Peak Forward Surge Current @t@=8.3ms	I _{FSM}	2.0	A
Power Dissipation	P _D	150	mW
Thermal Resistance From Junction To Ambient	R _{θJA}	250	°C/W
Junction Temperature	T _J	150	°C
Storage Temperature	T _{STG}	-55 ~+150	°C

ELECTRICAL CHARACTERISTICS (T_A = 25°C unless otherwise specified)

Parameter	Symbol	Min	Typ	Max	Unit	Conditions
Reverse Voltage	V _R	80			V	I _R =100uA
Forward voltage	V _F			0.7	V	I _F =5mA
				0.8		I _F =10mA
				1.0		I _F =100mA
				1.2		I _F =150mA
Reverse current	I _R			1	uA	V _R =80V
Diode capacitance	C _D			3	pF	V _R =0V,f=1MHz
Reverse recovery time	T _{RR}			4	nS	I _F =I _R =10mA,I _{tr} =0.1X I _R ,R _L =100Ω

SWITCHING DIODE

Typical Characteristics

Forward Characteristics

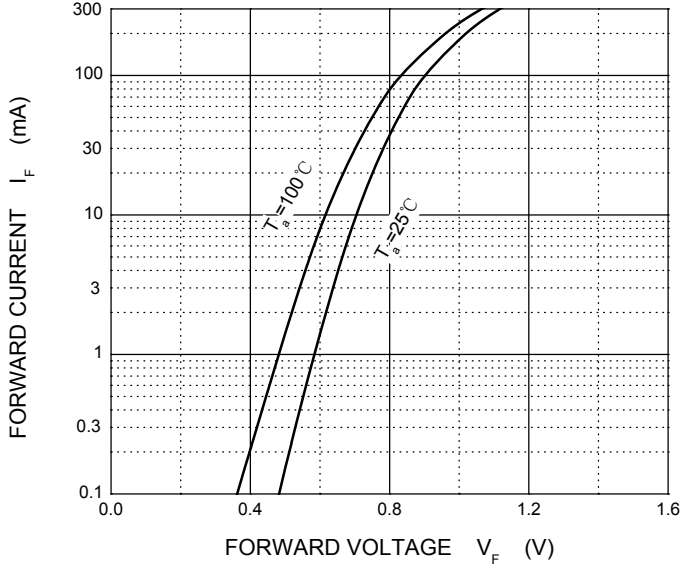

Reverse Characteristics

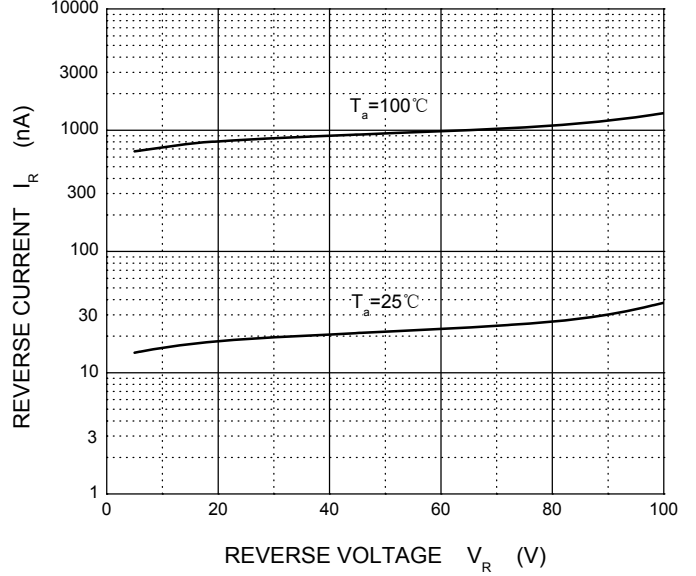

Capacitance Characteristics

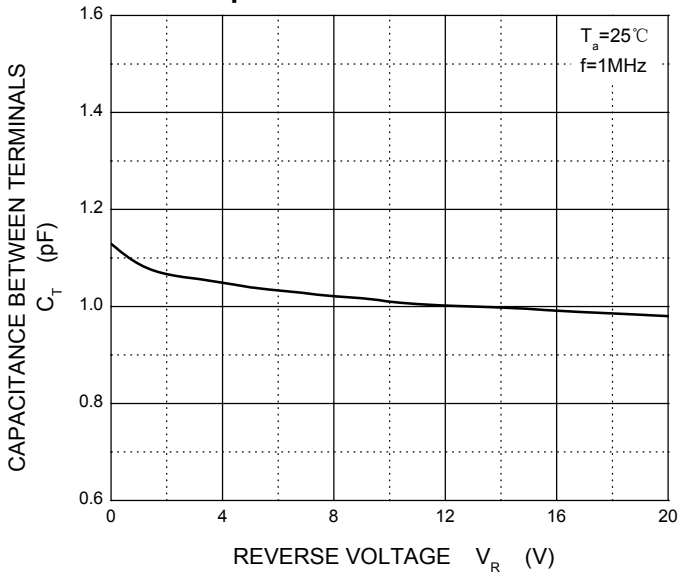

Power Derating Curve

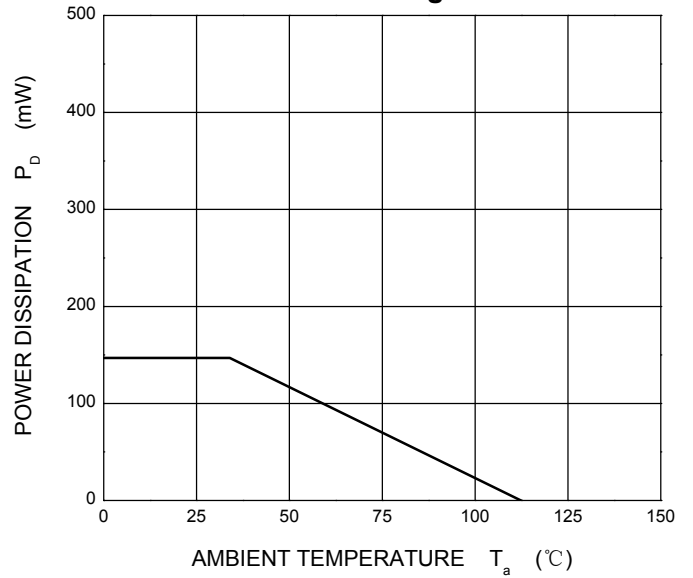

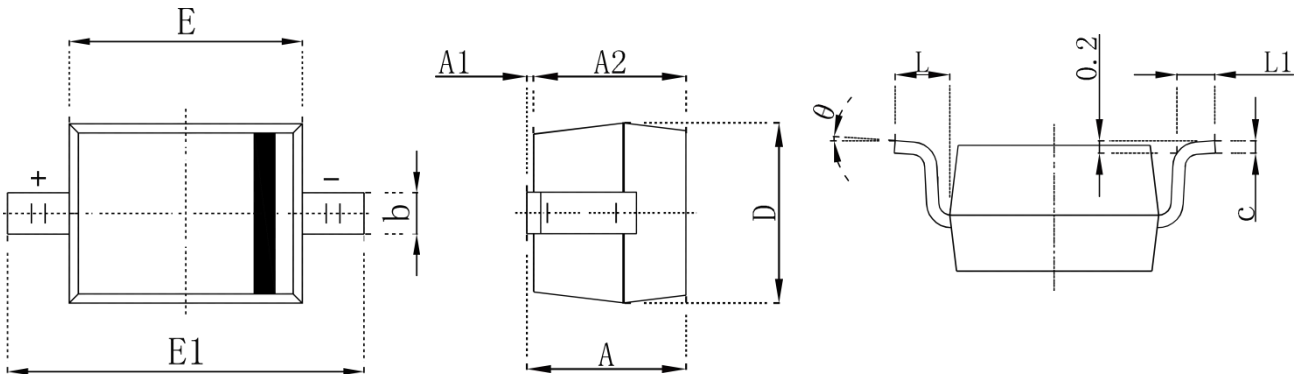
SWITCHING DIODE
SOD-123 Package Outline Dimensions

Symbol	Dimensions In Millimeters		Dimensions In Inches	
	Min.	Max.	Min.	Max.
A	1.050	1.250	0.041	0.049
A1	0.000	0.100	0.000	0.004
A2	1.050	1.150	0.041	0.045
b	0.450	0.650	0.018	0.026
c	0.080	0.150	0.003	0.006
D	1.500	1.700	0.059	0.067
E	2.600	2.800	0.102	0.110
E1	3.550	3.850	0.140	0.152
L	0.500REF		0.020 REF	
L1	0.250	0.450	0.010	0.018
θ	0°	8°	0°	8°

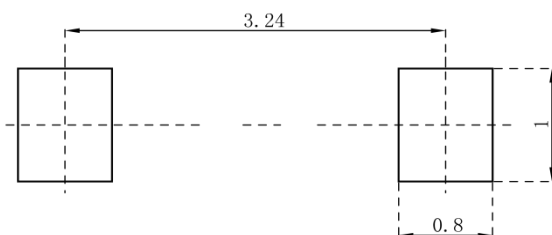
SOD-123 Suggested Pad Layout

Note:

1. Controlling dimension: in millimeters
2. General tolerance: $\pm 0.05\text{mm}$
3. The pad layout is for reference purposes only

SWITCHING DIODE

SOD-123 Tape and Reel

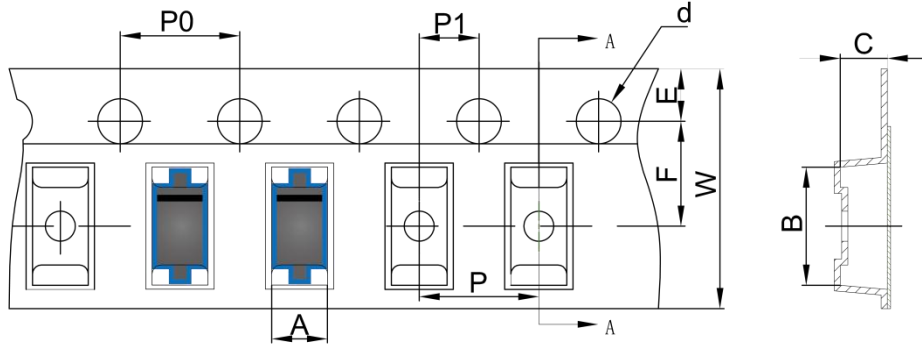
SOD-123 Embossed Carrier Tape



SOD-123 Tape Leader and Trailer

DIMENSIONS ARE IN MILLIMETER										
TYPE	A	B	C	d	E	F	P0	P	P1	W
SOD-123	1.85	3.95	1.57	Ø1.55	1.75	3.50	4.00	4.00	2.00	8.00
TOLERANCE	±0.1	±0.1	±0.1	±0.1	±0.1	±0.1	±0.1	±0.1	±0.1	±0.1

SOD-123 Reel

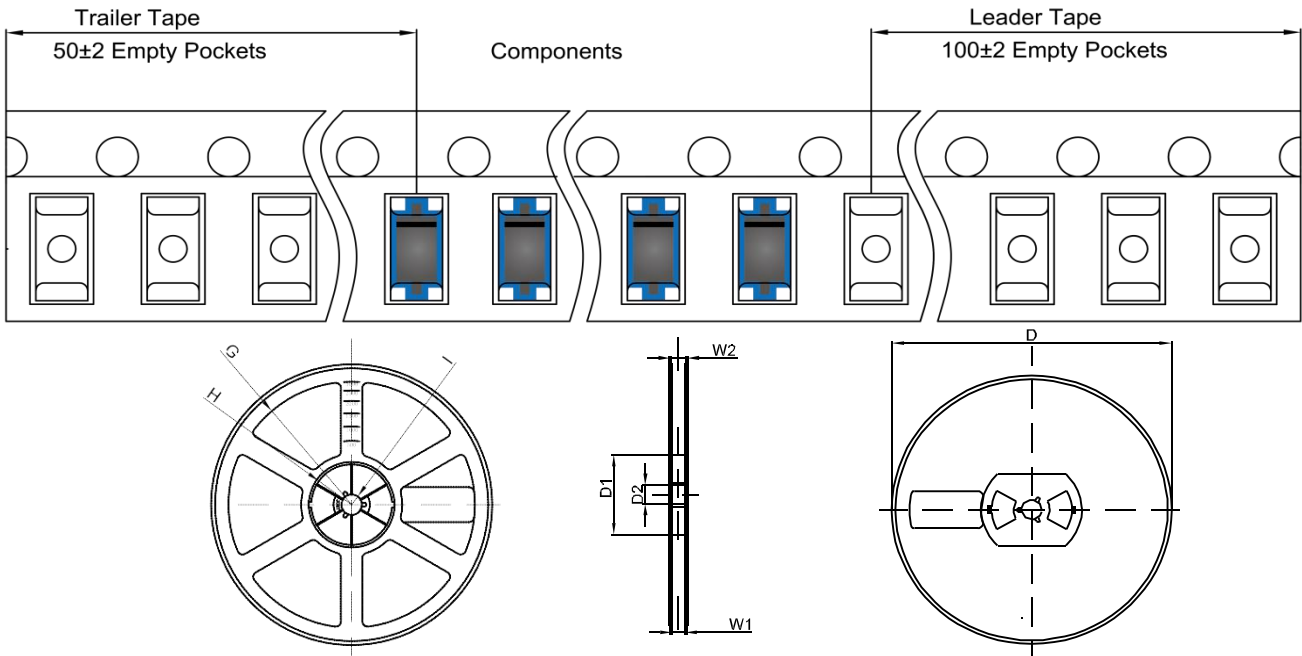

DIMENSIONS ARE IN MILLIMETER								
REEL OPTION	D	D1	D2	G	H	I	W1	W2
7" DIA	Ø178	54.40	13.00	R78	R25.60	R6.50	9.50	12.30
TOLERANCE	±2	±1	±1	±1	±1	±1	±1	±1